

FLIGHT MEDICAL INNOVATIONS Ltd.

FLIGHT 60 VENTILATOR

Service Manual

Models: SL; DL; iO₂



LIT-0021 Rev. A11

Aug 2016

CE₀₄₈₃

Legal Notice

Disclaimer

FLIGHT MEDICAL INNOVATIONS Ltd. (FLIGHT MEDICAL) provides this Service Manual in its commitment to help reduce patient risk and injury. However, this manual is not intended to in any way replace or substitute duty of care to a patient, professional responsibility, or professional judgment, nor is it intended to provide any warranty, promise, guarantee, assumption of risk or duty, release, or indemnity. Physicians shall at all times maintain responsibility for patient treatment and outcomes, and FLIGHT MEDICAL further assumes no liability for patient treatment or outcome or for physician's negligence, breach of duty of care, or malpractice.

The FLIGHT 60 Ventilator operator is solely responsible for selecting the appropriate level and method of patient monitoring.

Product modification or misuse can be dangerous. FLIGHT MEDICAL disclaims all liability for the consequences of product alterations or modifications, as well as for the consequences which might result from the combination of this ventilator with other products, whether supplied by FLIGHT MEDICAL or by other manufacturers, unless such a combination has been specifically endorsed by FLIGHT MEDICAL.

The design of FLIGHT 60 Ventilator, the Operator's and Service Manuals, and the labeling on the ventilator, take into consideration that the purchase and use of the equipment is restricted to trained professionals, and that certain inherent characteristics of the ventilator are known to the operator. Instructions, warnings, and caution statements are therefore limited to the specifics of the FLIGHT 60 Ventilator.



Federal law (US) restricts this device to sale by or on the order of a physician.

This Operator's Manual excludes references to various hazards which are obvious to medical professionals and operators of this equipment, to the consequences of product misuse, and to potential adverse effects in patients with abnormal conditions.

When the FLIGHT 60 Ventilator is used in homecare and subacute environments, only properly trained personnel should operate the ventilator. The FLIGHT 60 Ventilator is a restricted medical device designed for use by respiratory therapists or other properly trained and qualified personnel under the direction of a physician and in accordance with applicable state laws and regulations.

Transport of patients with the FLIGHT 60 Ventilator requires that medical staff have a good working knowledge of the ventilator's use and problem resolution. Proper emergency backup equipment must be immediately available during transport.

FLIGHT 60 Ventilator operators must recognize their responsibility for implementing safety monitoring mechanisms which supply appropriate information on equipment performance and patient condition. Patient safety may be achieved through a wide variety of means, such as electronic surveillance of equipment performance and

patient condition. However, equipment surveillance should not replace direct observation of clinical signs.

The liability of FLIGHT MEDICAL is subject to and limited to the exclusive terms and conditions as set forth herein. Said liability is limited whether arising out of, or related to, the manufacture and sale of goods, their installation, demonstration, sales representation, use, performance, or otherwise. Any liability based upon product warranty is limited regardless of any fault attributable to FLIGHT MEDICAL and the nature of the action (including breach of warranty, negligence, and strict liability).

The written warranties are in lieu of all other warranties, expressed or implied, including, without limitation, warranties of merchantability, fitness for any purpose, or non-infringement.

FLIGHT MEDICAL shall not be liable for any special incidental or consequential damages incurred by the buyer to a third party. The buyer shall not be entitled to make liability recoveries from FLIGHT MEDICAL due to such situations.

Warranty

The FLIGHT 60 Ventilator warranty does not apply for/ in case of:

- Defects caused by misuse, mishandling, tampering, or by modifications not authorized by FLIGHT MEDICAL or its representatives.
- Rubber and plastic components and materials, which are guaranteed to be free of defects at time of delivery.

Any product which proves during the warranty period to be defective in workmanship or material, will be replaced, credited, or repaired. FLIGHT MEDICAL retains the discretion to select the most suitable of these options. FLIGHT MEDICAL is not responsible for deterioration, wear, or abuse. In all cases, FLIGHT MEDICAL will not be liable beyond the original selling price.

Application of this warranty is subject to the following conditions:

- FLIGHT MEDICAL or its authorized representatives must be promptly notified upon detection of the defective material or equipment.
- Defective material or equipment must be returned to FLIGHT MEDICAL or its authorized representative.
- Examination by FLIGHT MEDICAL or its authorized representatives must confirm that the defect is covered by the terms of this warranty.

To ensure complete protection under this warranty, the Warranty Registration Card must be returned to a FLIGHT MEDICAL authorized representative within ten (10) days of equipment receipt.

The above is the sole warranty provided by FLIGHT MEDICAL. No other warranty, expressed or implied, is intended. Representatives of FLIGHT MEDICAL are not authorized to modify the terms of this warranty.

In no way does this or any of FLIGHT MEDICAL policies, training materials, guidelines, or instructions create an obligation for FLIGHT MEDICAL to perform any services.

About this Document

This document is a service manual for the FLIGHT 60 and F60 Dual Limb Ventilators, ventilators that provide continuous or intermittent mechanical ventilation support for the care of individuals who require mechanical ventilation. It is intended for technicians who are responsible for maintaining, servicing, and providing troubleshooting assistance for the FLIGHT 60 and F60 Dual Limb Ventilators.

For information on how to use the FLIGHT 60 Ventilator, see the *FLIGHT 60 Ventilator Operator's Manual*.

Style Conventions



Convention	Used for
Verdana	Regular text.
Arial Bold	Names of labels, buttons, and other elements of the user interface.
<i>Arial Italics</i>	Special terms, the first time they appear.
	Notes , which offer an additional explanation or a hint on how to overcome a common problem.
	Warnings , which indicate potentially damaging user operations and explain how to avoid them.

Table of Contents

1	INTRODUCTION	1-1
1.1	INTENDED USE	1-1
1.2	SYMBOLS	1-1
2	SAFETY INSTRUCTIONS	2-1
2.1	GENERAL WARNINGS	2-1
2.2	CAUTIONS	2-3
3	FUNCTIONAL DESCRIPTION.....	3-1
3.1	FRONT PANEL	3-1
3.1.1	Keypad / Control Buttons	3-2
3.1.2	LED Indicators	3-3
3.2	LEFT SIDE PANEL.....	3-4
3.3	RIGHT SIDE PANEL.....	3-5
3.4	BACK PANEL	3-6
3.5	REMOTE ALARM CONNECTION	3-8
3.6	VENTILATOR MODULES	3-9
3.7	VENTILATOR MODULES – <i>IO₂ INTERNAL MIXER MODEL</i>	3-10
3.8	PNEUMATIC DIAGRAM	3-11
3.9	PNEUMATIC DIAGRAM – <i>IO₂ INTERNAL MIXER MODEL</i>	3-12
3.10	ELECTRICAL DIAGRAM	3-13
3.11	ELECTRICAL DIAGRAM – <i>IO₂ INTERNAL MIXER MODEL</i>	3-14
4	REMOVING AND REINSTALLING MODULES	4-1
4.1	INTRODUCTION	4-1
4.2	REQUIRED EQUIPMENT	4-1
4.3	REPLACING THE DETACHABLE BATTERY	4-2
4.3.1	Removing the Detachable Battery	4-2
4.3.2	Installing the Detachable Battery	4-2
4.4	REPLACING THE INTERNAL BATTERY	4-2
4.4.1	Removing the Internal Battery	4-2
4.4.2	Installing the Internal Battery	4-3
4.5	REMOVING THE VENTILATOR COVER.....	4-3
4.5.1	Removing the Ventilator Cover	4-3
4.5.2	Installing the Ventilator Cover	4-6
4.6	REPLACING THE POWER BOARD	4-6
4.6.1	Removing the Power Board	4-6
4.6.2	Installing the Power Board	4-9

Table of Contents

4.7	REPLACING THE POWER SUPPLY.....	4-10
4.7.1	Class I Power Supply.....	4-10
4.7.2	Class II Power Supply.....	4-13
4.8	REPLACING THE FRONT PANEL ASSEMBLY	4-14
4.8.1	Removing the Front Panel Assembly.....	4-14
4.8.2	Connecting the Front Panel Assembly	4-17
4.9	REPLACING THE O ₂ MIXER NEB BOARD * (<i>IO₂ INTERNAL MIXER MODEL ONLY</i>).....	4-17
4.9.1	Removing the O ₂ mixer neb board.....	4-17
4.9.2	Installing the O ₂ mixer board.....	4-17
4.10	REPLACING THE MAIN BOARD	4-18
4.10.1	Removing the Main Board	4-18
4.10.2	Installing the Main Board	4-21
4.11	REPLACING THE TOUCH SCREEN	4-21
4.12	REPLACING THE MANIFOLD ASSEMBLY	4-22
4.12.1	Removing the Manifold Assembly	4-22
4.12.2	Installing the Manifold Assembly	4-26
4.13	REPLACING THE OXYGEN SENSOR	4-27
4.13.1	Removing the Oxygen Sensor.....	4-27
4.13.2	Installing the Oxygen Sensor.....	4-28
4.14	REPLACING THE O ₂ LEAK SENSOR * (<i>IO₂ INTERNAL MIXER MODEL ONLY</i>).....	4-28
4.14.1	Removing the O ₂ leak sensor.....	4-28
4.14.2	Installing the O ₂ leak sensor.....	4-28
4.15	REPLACING THE OXYGEN MIXER * (<i>IO₂ INTERNAL MIXER MODEL ONLY</i>).....	4-29
4.15.1	Removing the Oxygen mixer	4-29
4.15.2	Installing the Oxygen mixer	4-30
4.16	REPLACING THE O ₂ MIXER FILTERS * (<i>IO₂ INTERNAL MIXER MODEL ONLY</i>).....	4-31
4.17	REPLACING THE PURGE BOARD ASSEMBLY	4-31
4.17.1	Removing the Purge Board Assembly.....	4-31
4.17.2	Installing the Purge Board Assembly	4-32
4.18	REPLACING THE SOLENOID BOARD ASSEMBLY	4-32
4.18.1	Removing the Solenoid Board Assembly.....	4-32
4.18.2	Installing the Solenoid Board Assembly.....	4-33
4.19	REPLACING THE SOLENOID ASSEMBLY	4-34
4.19.1	Removing the Solenoid Assembly.....	4-34
4.19.2	Installing the Solenoid Assembly.....	4-36
4.20	REPLACING THE LOWER BOARD AND D-TYPE BOARD.....	4-36
4.20.1	Removing the Lower Board and D-type Board.....	4-36
4.20.2	Installing the Lower Board and D-type Board.....	4-38
4.21	REPLACING THE FUSE.....	4-39

4.21.1 Removing the Fuse.....	4-39
4.21.2 Installing the Fuse	4-39
4.22 REPLACING THE RUBBER BUMPERS	4-40
4.22.1 Removing the Rubber Bumpers.....	4-40
4.22.2 Installing the Rubber Bumpers.....	4-40
5 SERVICE/TECHNICAL MENU.....	5-1
5.1 ADVANCED SCREEN	5-1
5.2 SERVICE SCREEN.....	5-2
6 SOFTWARE UPGRADE.....	6-4
6.1 INSTALLING THE SW UPGRADE.....	6-4
6.2 CALIBRATION INTEGRITY CHECK.....	6-4
7 CALIBRATION AND VERIFICATION TESTS	7-6
REQUIRED EQUIPMENT	7-6
7.1 CALIBRATION	7-6
7.1.1 Pressure Relief Calibration.....	7-6
7.1.2 Pressure Sensors Calibration	7-7
7.1.3 Volume Factor Calibration	7-10
7.1.4 Oxygen Sensor Calibration	7-11
7.1.5 O ₂ Leak Sensor calibration* (<i>iO₂ Internal mixer model only</i>)....	7-12
7.2 OPERATIONAL VERIFICATION PROCEDURE (OVP)	7-13
7.2.1 Standard Ventilator Settings (STS).....	7-13
7.2.2 Front Panel Self Test	7-13
7.2.3 Circuit Test	7-14
7.2.4 Volume verification	7-15
7.2.5 Pressure Verification.....	7-15
7.2.6 PEEP	7-16
7.2.7 Pressure Trigger	7-17
7.2.8 Exhalation Valve Leak.....	7-18
7.2.9 High Pressure Alarm.....	7-19
7.2.10 Battery /Charger /Power Supply	7-19
7.2.11 Inlet Leak	7-20
7.2.12 Buzzer Test	7-21
7.2.13 Oxygen Calibration Test.....	7-21
7.2.14 Nebulizer compensation test * (<i>iO₂ Internal mixer model only</i>)	7-22
7.2.15 OVP Test Results.....	7-23
7.3 TEST TABLE	7-24
8 MAINTENANCE.....	8-1
8.1 SCHEDULED MAINTENANCE.....	8-1
8.2 DOWNLOAD LOG FILES	8-1
9 TROUBLESHOOTING GUIDE	9-3

Table of Contents

9.1	INTRODUCTION	9-3
9.2	ERROR MESSAGES	9-3
10	REPACKAGING AND SHIPPING	10-1
	RGA RETURNS	10-1
11	SPARE PARTS.....	11-2
11.1	ELECTRONIC	11-2
11.2	MECHANICAL / ASSEMBLIES	11-5
11.3	CABLES	11-8









1 Introduction

This Service Manual (V60-00002-18 Rev. A) provides information for servicing the FLIGHT 60 Ventilator. It is for use by authorized service personnel while installing, servicing, and repairing the ventilator.

1.1 Intended Use













The FLIGHT 60 Ventilator is intended to provide continuous or intermittent mechanical ventilation support for the care of individuals who require mechanical ventilation. Specifically, the FLIGHT 60 Ventilator is applicable for adult and pediatric patients, greater than or equal to 10 kg (22 lbs).

1.2 Symbols

Symbol	Description
Front Panel	
	On/Off
	Alarm Reset
	OK (Enter)
	Decrease Button
	Increase Button
	Cancel
	Panel Lock
	Manual Breath
	Parameters Screen

Introduction

Symbols

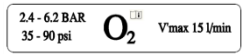
Symbol	Description
	Extended Screen
	Technical Screen
	Nebulizer Port
Rear Panel	
	Caution; consult accompanying documents
	Type BF applied part
	Temperature limitation
	Humidity limitation
	Atmospheric pressure limitation
	DC - Direct Current
	AC - Alternating Current
	USB - Universal Serial Bus
	LAN - Local Area Network
	High Pressure and Low-Flow Oxygen Port

2 Safety Instructions

At all times, strictly follow this manual. The safe use of the FLIGHT 60 Ventilator requires full understanding of its operation, and adherence to the manual's instructions. The equipment is only to be used for the purpose specified in section 1.1. Observe all of the WARNINGS and CAUTIONS posted in this manual, and on buttons found on the FLIGHT 60 Ventilator and associated accessories.

2.1 General Warnings



External power connection: To maintain grounding integrity when using AC power, only connect to grounded receptacles. Always disconnect the external power prior to servicing. There is a risk of explosion if used in the presence of flammable anesthetics.



All settings and adjustments in the different ventilation modes must be made in accordance with a physician's prescribed therapy.



Do not use electrically conductive patient circuits.



Always use a clean, disinfected patient circuit.



Always use an outlet filter or equivalent at the Airway Pressure Connector, to protect the internal sensors from moisture and other contaminants.



The ventilator is ready for operation only when:

1. It is completely assembled.
2. The OVP has been successfully completed.



Failure to identify and correct alarm violations may result in patient injury.

Safety Instructions

General Warnings



Ensure that the oxygen source is not empty before and during the use of the optional Air/Oxygen Entrainment Mixer or Oxygen Blending Bag Kit.



As Li-Ion batteries are charged and discharged over time, their ability to hold a charge is decreased with use. This can shorten the amount of time the ventilator can function while on battery power.



The batteries should be replaced when the batteries no longer meet the needs of the user. This depends on a number of factors including settings and usage patterns.



Charge the batteries for a minimum of three hours before powering the ventilator from the batteries. This provides fully charged batteries.



During storage, charge the batteries for a minimum of three hours every 30 days. This provides charged batteries.



Always ensure that the green Ext. Power LED is illuminated after connecting the FLIGHT 60 Ventilator to an external AC or DC power source. If the LED is not illuminated, check all power connections and resolve any problems.



Always plug the FLIGHT 60 Ventilator into an AC power supply source when not in use, to ensure best battery performance.



The flow resistance of the air inlet filter, located on the right side of the ventilator, is likely to increase with repeated use. Ensure that the filter is changed regularly.



Only a FLIGHT MEDICAL approved patient circuit can be used with the FLIGHT 60 Ventilator.



Only a FLIGHT MEDICAL approved exhalation valve can be used with the FLIGHT 60 Ventilator.



Perform a Circuit Test each time a clean circuit/exhalation valve is installed.



This FLIGHT 60 Ventilator has been tested and found to comply with the EMC limits according to the EN60601-1-1-2 standard class B. These limits are designed to provide reasonable protection against harmful interference in a typical medical installation. The equipment generates uses and can radiate radio frequency energy and, if not installed and used in accordance with these instructions, may cause harmful interference to other devices in the vicinity. However, there is no guarantee that interference will not occur in a particular installation. If this equipment does cause harmful interference with other devices, which can be determined by turning the equipment off and on, the user is encouraged to try to correct the interference by one or more of the following measures:

Reorient or relocate the receiving device.

Increase the distance between the equipment.

Connect the equipment into an outlet on a circuit different from that to which the device (s) is connected.

Consult the manufacturer for help.

2.2 Cautions



Only use medical grade oxygen with the Air/Oxygen Entrainment Mixer or Oxygen Blending Bag Kit.



Do not place liquid containers in the immediate vicinity or on top of the FLIGHT 60 Ventilator. Liquids that get into the ventilator can cause equipment malfunction and damage.



After the FLIGHT 60 Ventilator is serviced, it must completely pass an Operational Verification Procedure (OVP) before being returned to patient use.

Safety Instructions

Cautions



An authorized FLIGHT MEDICAL factory-trained technician must do all service or repairs performed on the FLIGHT 60 Ventilator.



Do not open the ventilator or perform service on an open unit while connected to external power.



Use standard antistatic techniques while working inside the ventilator or handling any electronic parts.



Clean all external accessories of the ventilator prior to servicing.



Water in the oxygen supply can cause equipment malfunction and damage.



Batteries contain Li-Ion. Do not discard them in an incinerator or force them open. Batteries should not be disposed of with normal waste.



Use the tools and equipment specified in this manual to perform specific procedures.

3 Functional Description

3.1 Front Panel

The front panel contains the control buttons, visual indicators, display screen, and patient circuit connection. There are 2 types of keypad – symbols or print.

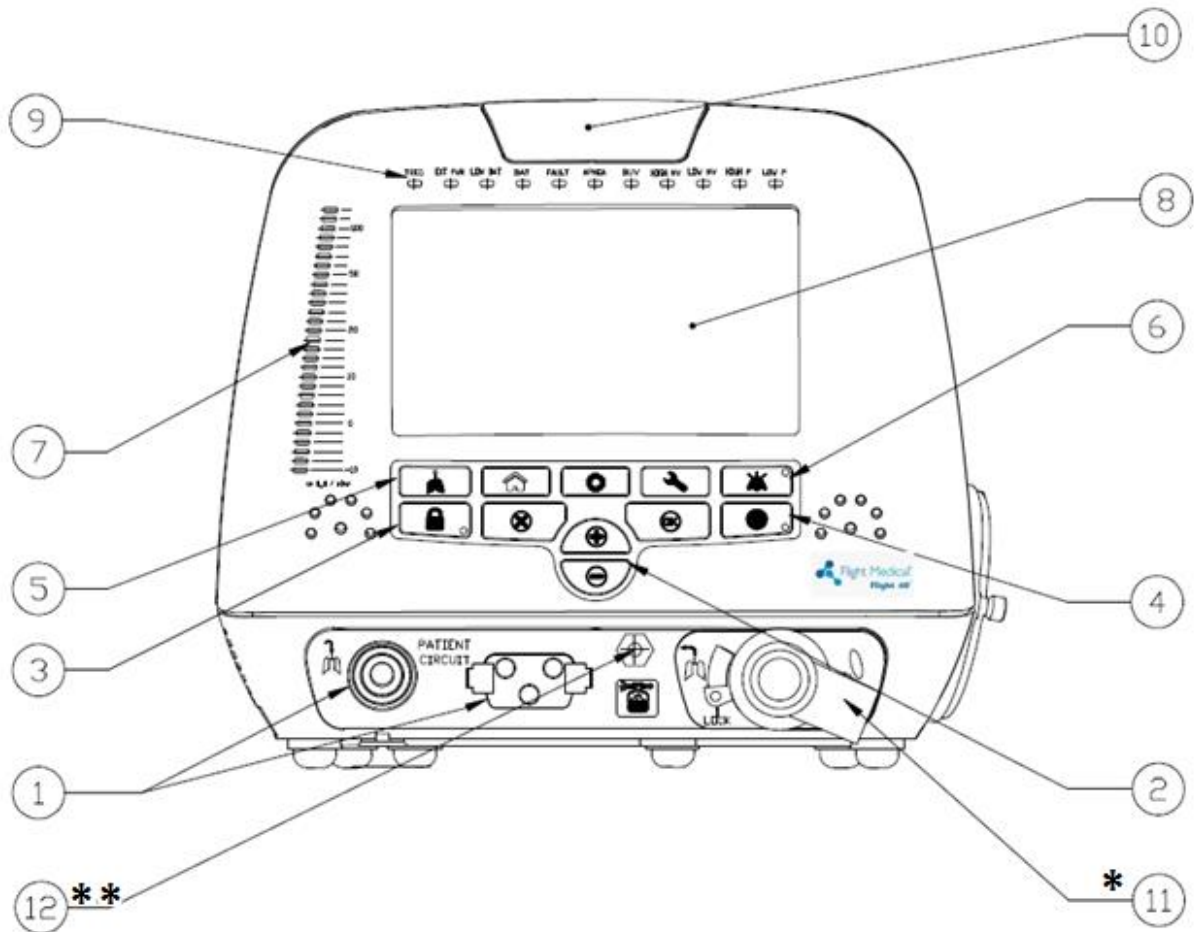

Figure 1 – Front Panel

Label	Name	Description
1	Patient Circuit Connector	Composed of a gas outlet and quick connector.
2	+/- button	Enables the user to adjust setting parameters.
3	Panel Lock button	Enables the user to lock the ventilator’s control, preventing accidental changes. Pressing the button of a locked panel and then Enter, unlocks the panel.
4	On/Off button	Turns the ventilator on or off, to start or stop ventilation.
5	Manual Breath button	Delivers a user initiated manual inflation.
6	Audio Paused / Alarm Reset button	Toggle button. Pressing Audio Paused temporarily silences the audible alarm; pressing Alarm Reset clears lit alarm LEDs.

Functional Description

Front Panel

Label	Name	Description
7	Pressure Gauge	The pressure gauge is a visual indicator of breath activity, which shows the dynamic movements of the breath pressures. When a breath is being delivered, the user can see the relative pressure and phase of the breath (inspiration or expiration). The pressure gauge is comprised of 29 LEDs. From -10 to +20 cmH ₂ O, each notch equals 2 cmH ₂ O; from 20 to 50 cmH ₂ O, each notch equals 5 cmH ₂ O; above 50 cmH ₂ O, each notch equals 10 cmH ₂ O.
8	Display touch screen	Enables the user to modify the ventilation, alarm, and technical settings, and to view real time patient data, alarms, battery status and logs.
9	LED Indicators	Inform the user of various events.
10	Primary Alarm LED	Flashes red to indicate that there is a high priority alarm.
11*	Dual Limb Exhalation Valve (DL model only)	Connects the patient circuit expiratory limb.
12**	Nebulizer Port (iO ₂ Internal mixer model only)	Connects to the pneumatic nebulizer.

3.1.1 Keypad / Control Buttons

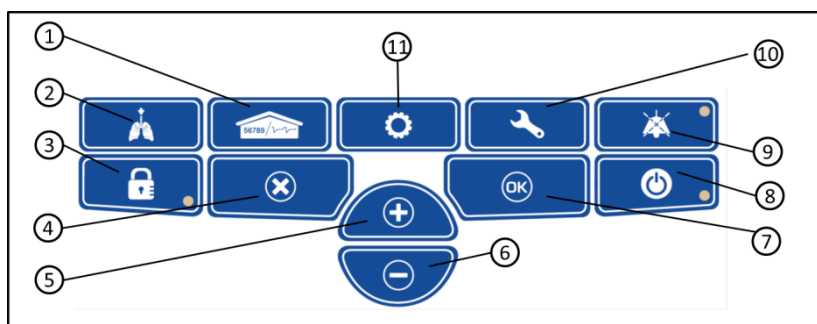











Figure 2 – Keypad / Control buttons

Item	Symbol	Description
1 – Parameters (home)		The Parameters screen is the Flight 60's default screen. Display switches automatically to Parameters from the other screens if not operated for 30 seconds. Use the Parameters button to toggle between the numeric and the graphic displays.
2 – Manual Breath		Delivers a user initiated manual inflation.

Item	Symbol	Description
3 – Panel Lock		Enables the user to lock the ventilator's control, preventing accidental changes. Pressing the button of a locked panel and then Enter, unlocks the panel.
4 – Cancel		Enable the user to cancel parameters change.
5 – Increase Button		Enables the user to adjust setting parameters upwards.
6 – Decrease Button		Enables the user to adjust setting parameters downwards.
7 – OK (Enter)		Enable the user to confirm parameters or mode change.
8 – On/Off		Turns the ventilator on or off, to start or stop ventilation.
9 – Alarm Reset		The Alarm Reset silences the audible alarm and clears lit alarm LEDs.
10 – Technical		Technical data and selection options.
11 – Extended		Additional ventilation parameters screen.

3.1.2 LED Indicators

The LED indicators on the front panel inform the user of various events.

The following table describes the available LED indicators.

LED Indicator	Description
TRIG	Green LED indicates a patient's breathing effort.
EXT PWR	Yellow LED indicates that an external power source is being applied to the ventilator.
LOW BAT	Red LED indicates that total batteries charge level is below 50%.
BAT	Orange LED indicates that the ventilator is powered on batteries.
FAULT	Red LED indicates a ventilator malfunction.
APNEA	Red LED indicates that no breaths have been delivered for the preset APNEA interval.
BUV	Red LED indicates that backup ventilation is active.
HIGH MV	Red LED indicates that the high inspiratory minute volume alarm limit is being violated.
LOW MV	Red LED indicates that the low inspiratory minute volume alarm limit is being violated.
HIGH P	Red LED indicates that the high peak airway pressure alarm limit is being violated.
LOW P	Red LED indicates low peak airway pressure.

3.2 Left Side Panel

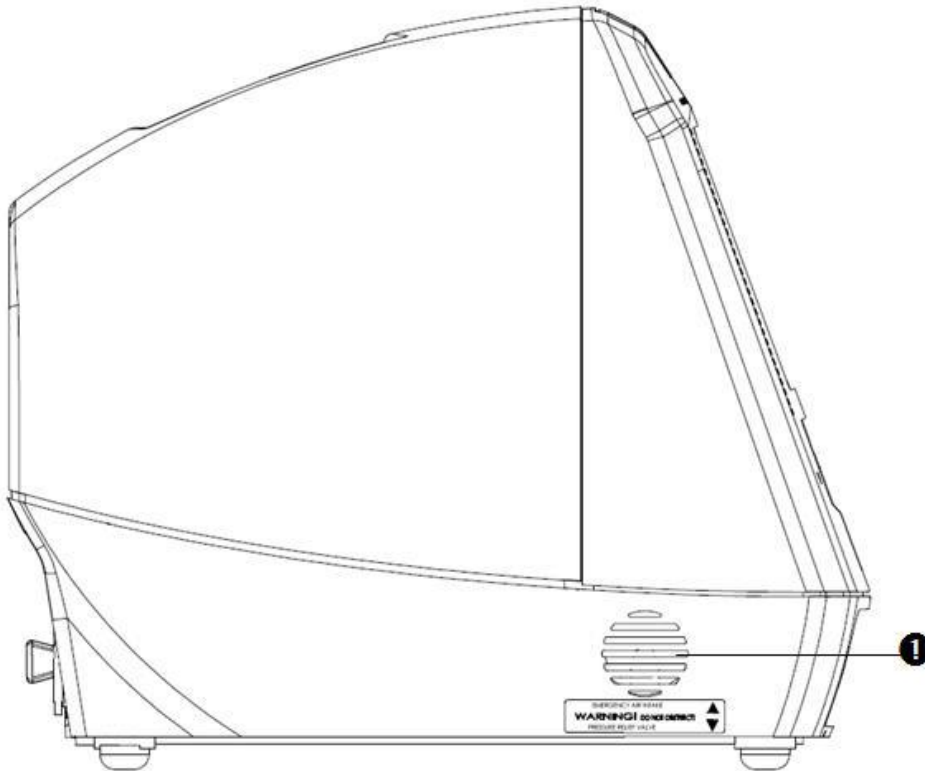

Figure 3 – Left Side Panel

Label	Name	Description
1	Emergency Air Intake	Enables the patient to pull ambient air into the patient circuit in the event of a complete system failure. The Air Intake opening pressure is approximately -3 cmH ₂ O (-3 mbar).

3.3 Right Side Panel

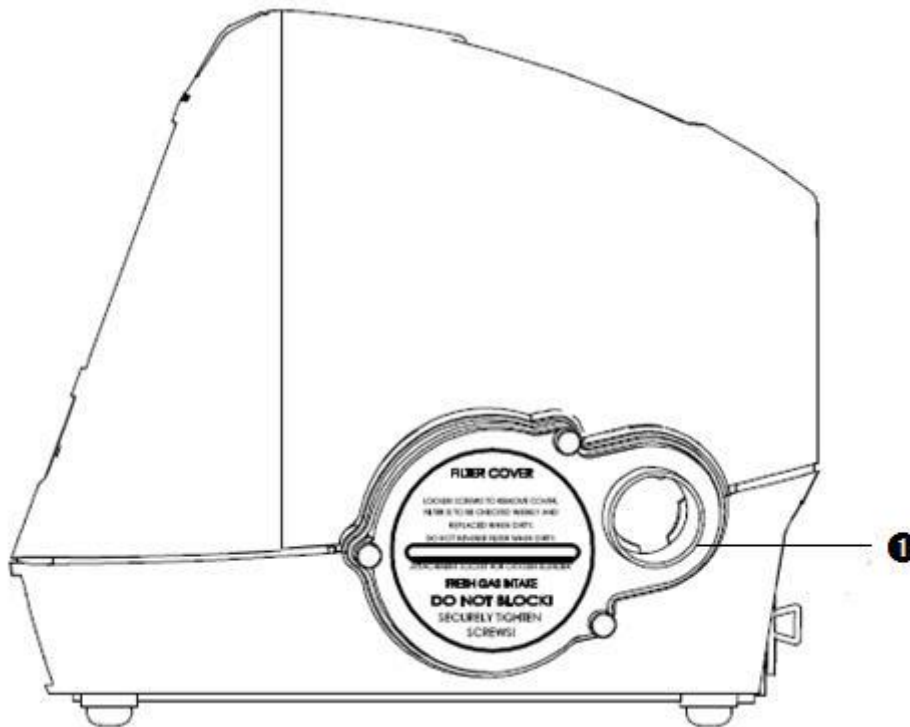

Figure 4 - Right Side Panel

Label	Name	Description
1	Fresh Gas Intake and Filter Cover	Environmental air enters through this 30 mm ID Fresh Gas Intake. The air inlet particle filter is placed behind the Filter Cover to protect the patient as well as the ventilator's piston system from dirt and particles. The Fresh Gas Intake also serves as the attachment socket for the optional FLIGHT 60 Ventilator Air/Oxygen Entrainment Mixer or Oxygen Blending Bag.

3.4 Back Panel

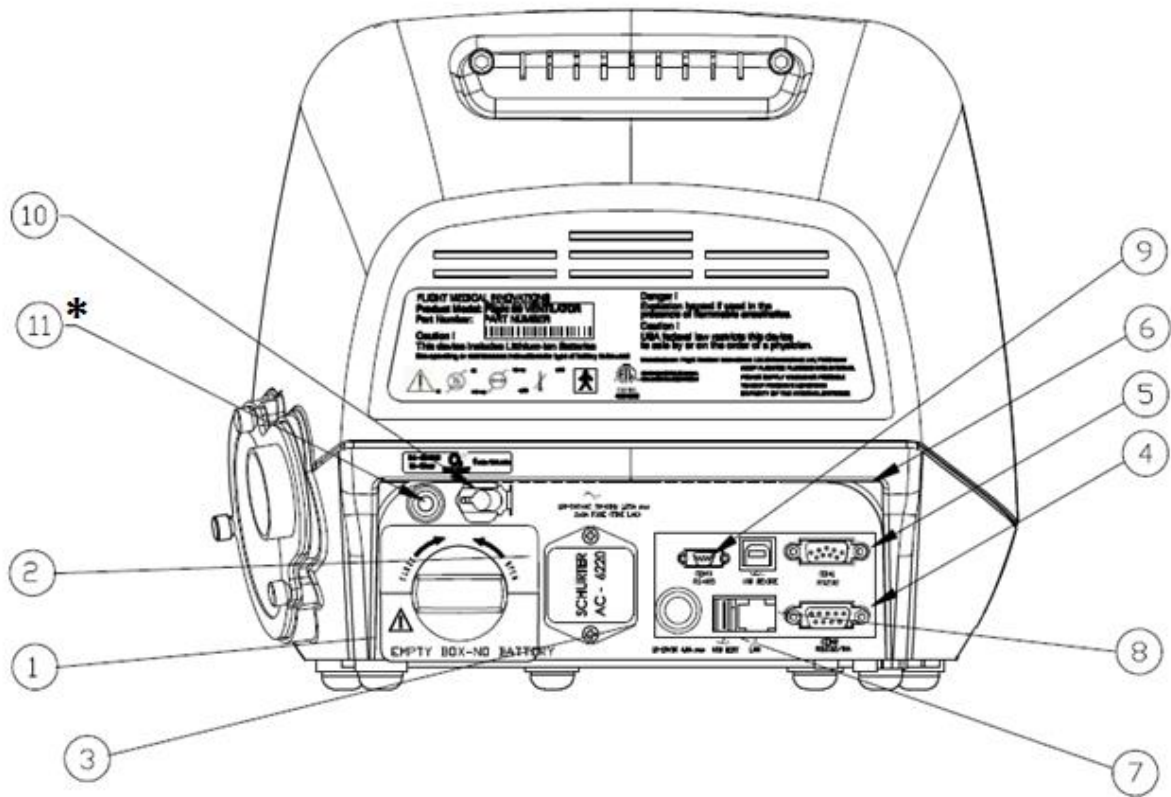

Figure 5 – Back Panel



To ensure proper grounding and prevent possible shock hazards, this device should only be connected to grounded power receptacles.

Label	Name	Description
1	Detachable Battery	Li-Ion 14.8 VDC
2	AC Connector with Fuses	100 – 240 V AC, 50 – 60 Hz, Fuses 2x8A (time lag)
3	DC Connector	12 – 15 V DC
4	RS-232 Serial Port (COM2)	Remote alarm connector (Normally Open and Normally Closed options).
5	RS-232 Serial Port (COM1)	Online output of events and error messages to the PC, using a dedicated PCS2 protocol; for authorized and qualified service technicians only.
6	USB B type	PC connector: USB port for downloading the main application from the PC using a dedicated PCS2 protocol; for authorized and qualified service technicians only.

Label	Name	Description
7	USB A type	USB port for uploading LOG files to an external memory stick; for authorized and qualified service technicians only.
8	LAN (RJ45)	LAN for network logging (currently not available).
9	Mini RS-485 (COM3)	For connecting FLIGHT MEDICAL peripherals. For future use.
10	Low Flow Oxygen Port	Low flow oxygen enrichment source.
11*	High Pressure O ₂ Port (<i>iO₂</i> <i>Internal mixer model only</i>)	Connects to high pressure O ₂ .

3.5 Remote Alarm Connection

The Flight-60 ventilator can be connected to third party remote alarm system. The remote alarm station displays all visible and audible alarms and alerts if the ventilator is shutdown.

Remote alarm cable should be connected to the COM2 RS232/RA port (the lower port) in the back of the ventilator. The COM2 port provides a dry contact output, both Normally Open (NO) and Normally Closed (NC).

- Normally Open – Pin 7 – closing the contacts to transmit an alarm.
- Normally Closed – Pin 8 – opening the contacts to transmit an alarm.

The dry contacts current should not exceed 1mA.

The voltage on the contacts must be lower than 12 Volts.

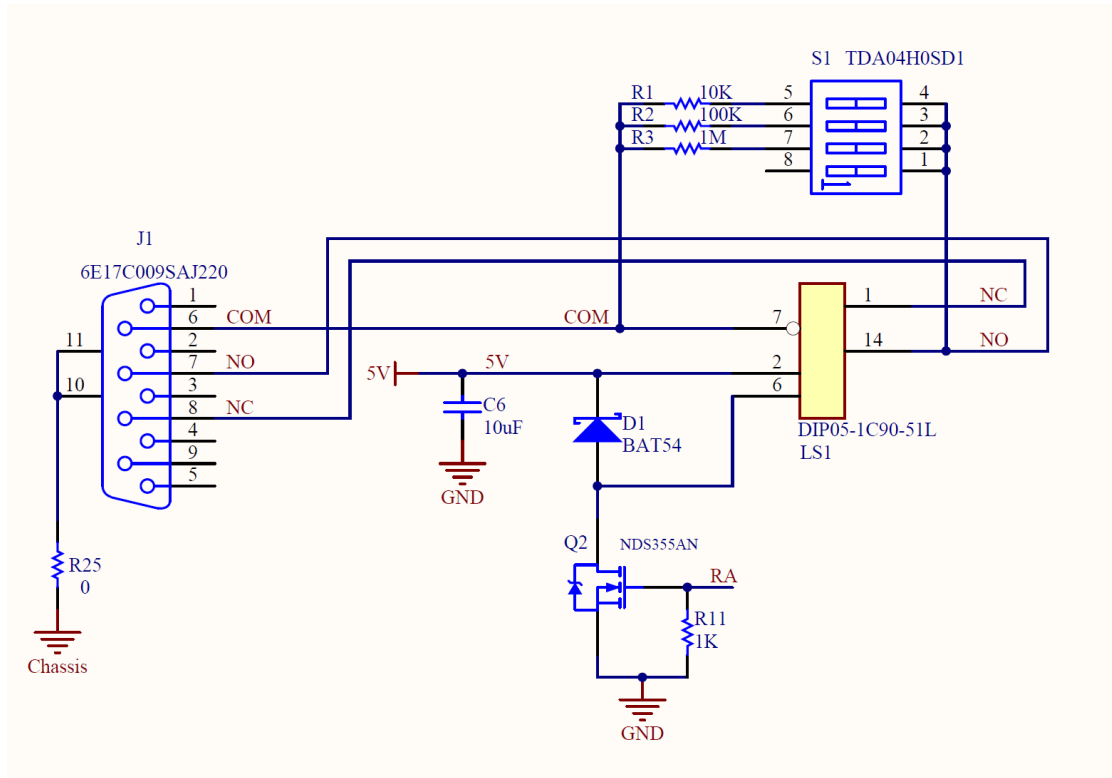

Remote Alarm Electrical schematics

! The legal and regulatory responsibility for this integration of the Flight 60 device into any external system lays on the integrator and not the Flight 60 manufacturer. This include but is not limited to responsibilities for the Design, Implementation, Installation validation verification and safety of the connection of the Flight-60 to the remote alarm. Falling to comply with the specification given here may result in damage to the device and will void its warranty.

3.6 Ventilator Modules

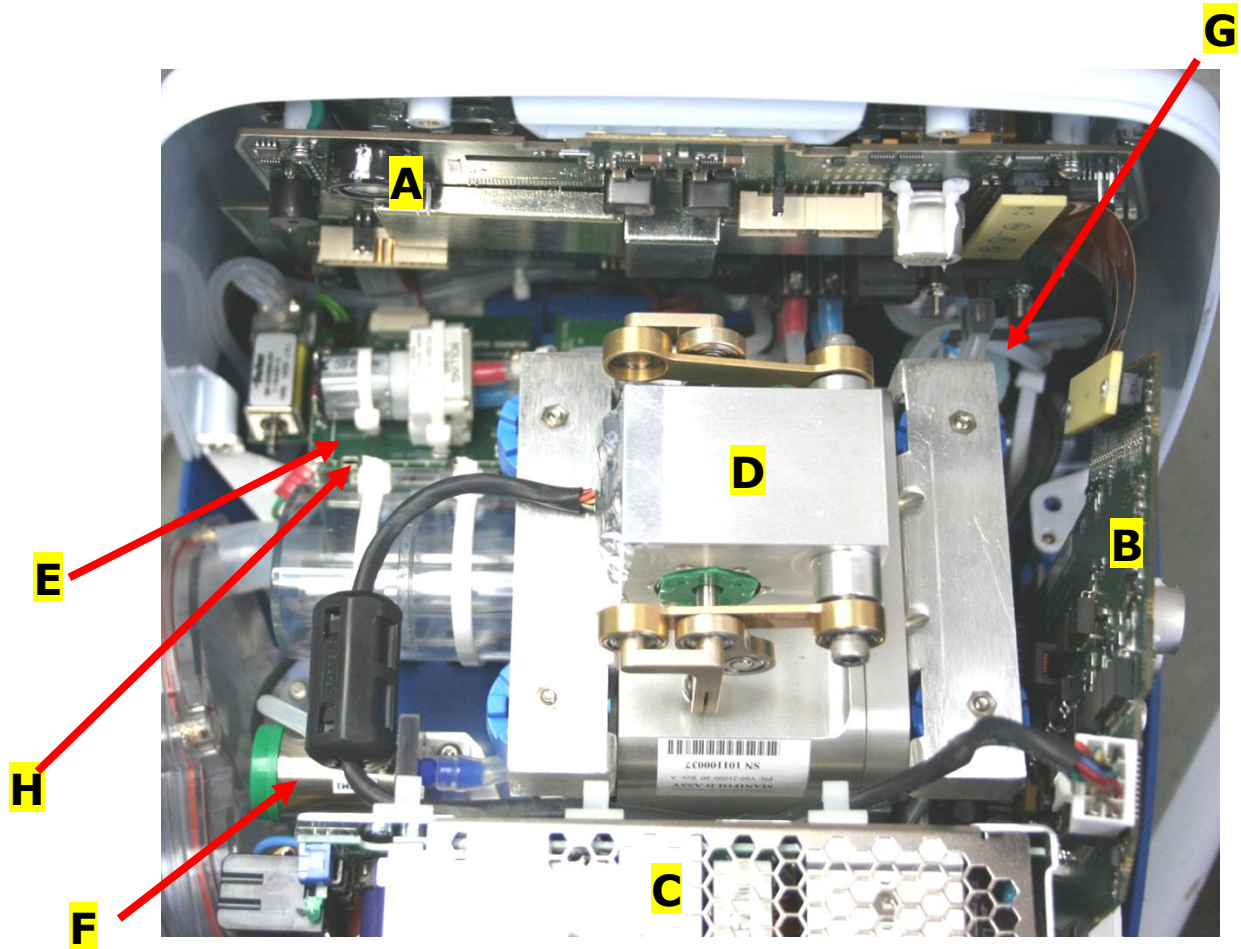

Figure 6 – Ventilator Modules

Component	P/N
A Main board (MB)	V60-60002-65
B Power board (PB)	V60-21000-65
C Power supply (PS)	V60-13000-65
D Manifold assembly	V60-21000-60
E Solenoid board assembly	V60-26000-65
F Solenoid assembly	V60-21400-69
G Oxygen (O ₂) Sensor	V60-25000-29
H Purge board	V60-23000-65

3.7 Ventilator Modules – iO₂ Internal mixer model

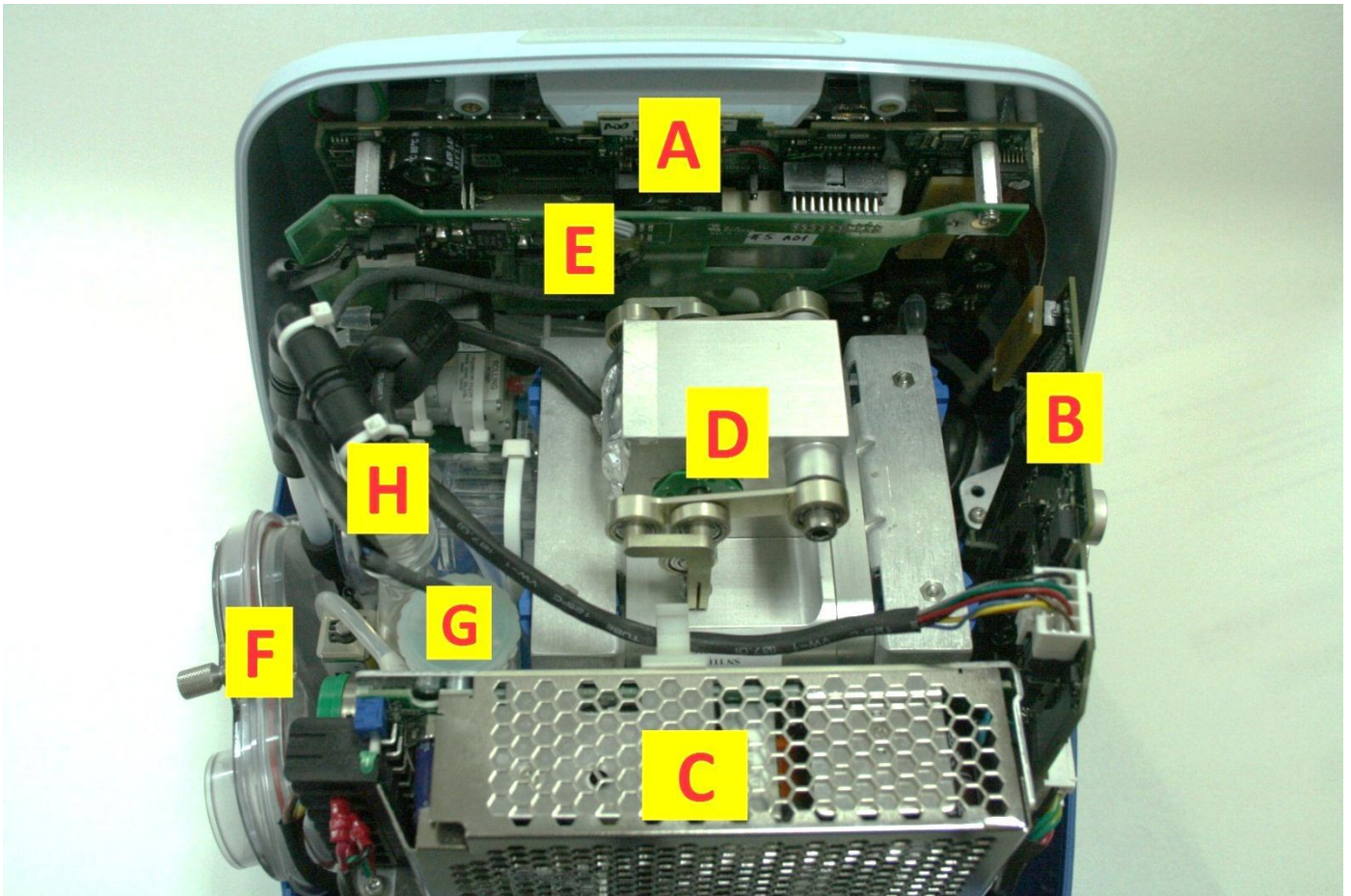
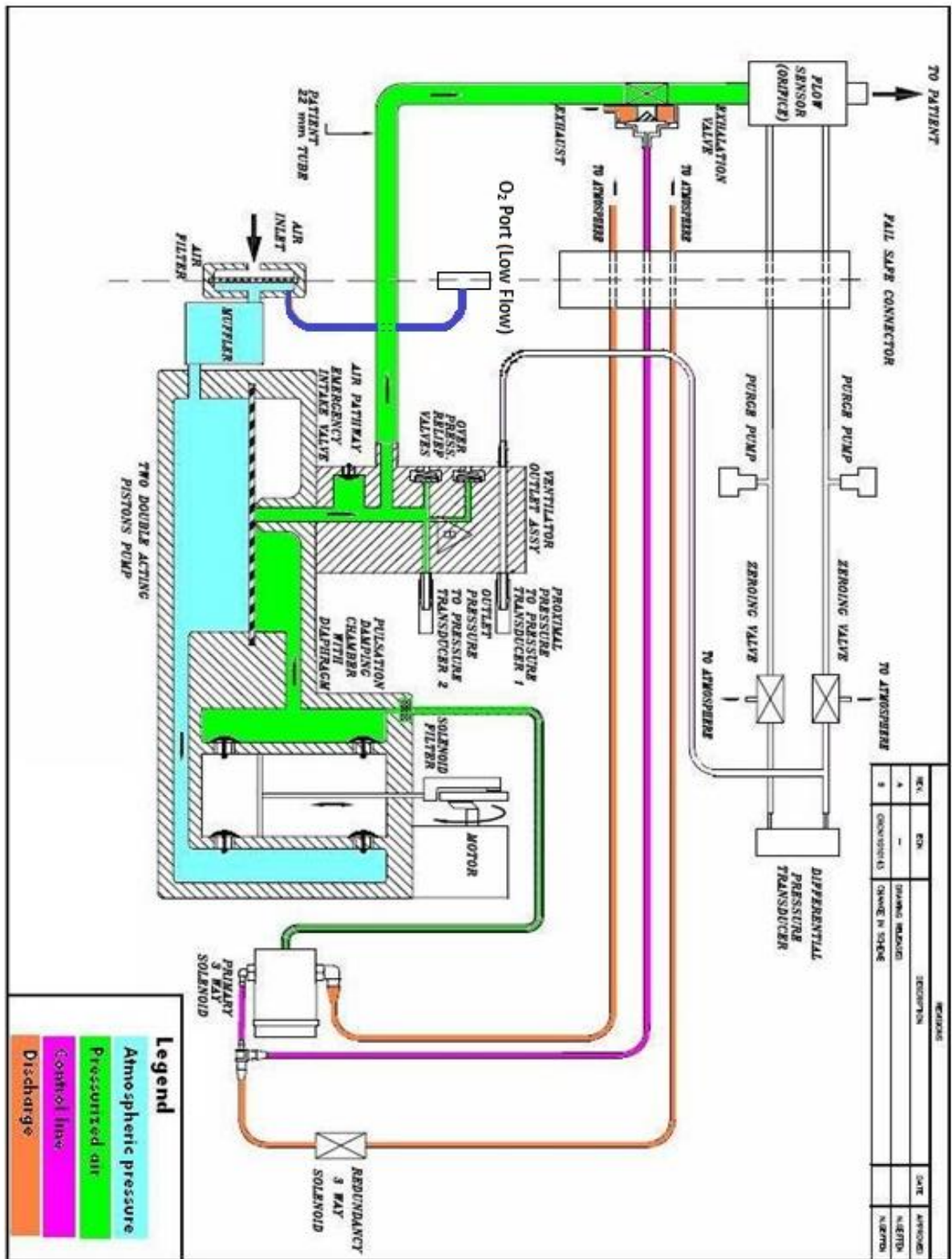

Figure 7 – Ventilator Modules Internal Mixer

Component	P/N
A Main board (MB)	V60-60002-65
B Power board (PB)	V60-21000-65
C Power supply (PS)	V60-13000-65
D Manifold assembly	V60-21000-60
E O ₂ Mixer Neb board	ELE-0001
F Inlet assembly	V60-21400-69
G O ₂ leak sensor	G60-25000-29
H Internal O ₂ mixer	SUB-0101

3.8 Pneumatic Diagram



Functional Description

Pneumatic Diagram – iO2 Internal mixer model

3.9 Pneumatic Diagram – *iO₂ Internal mixer model*

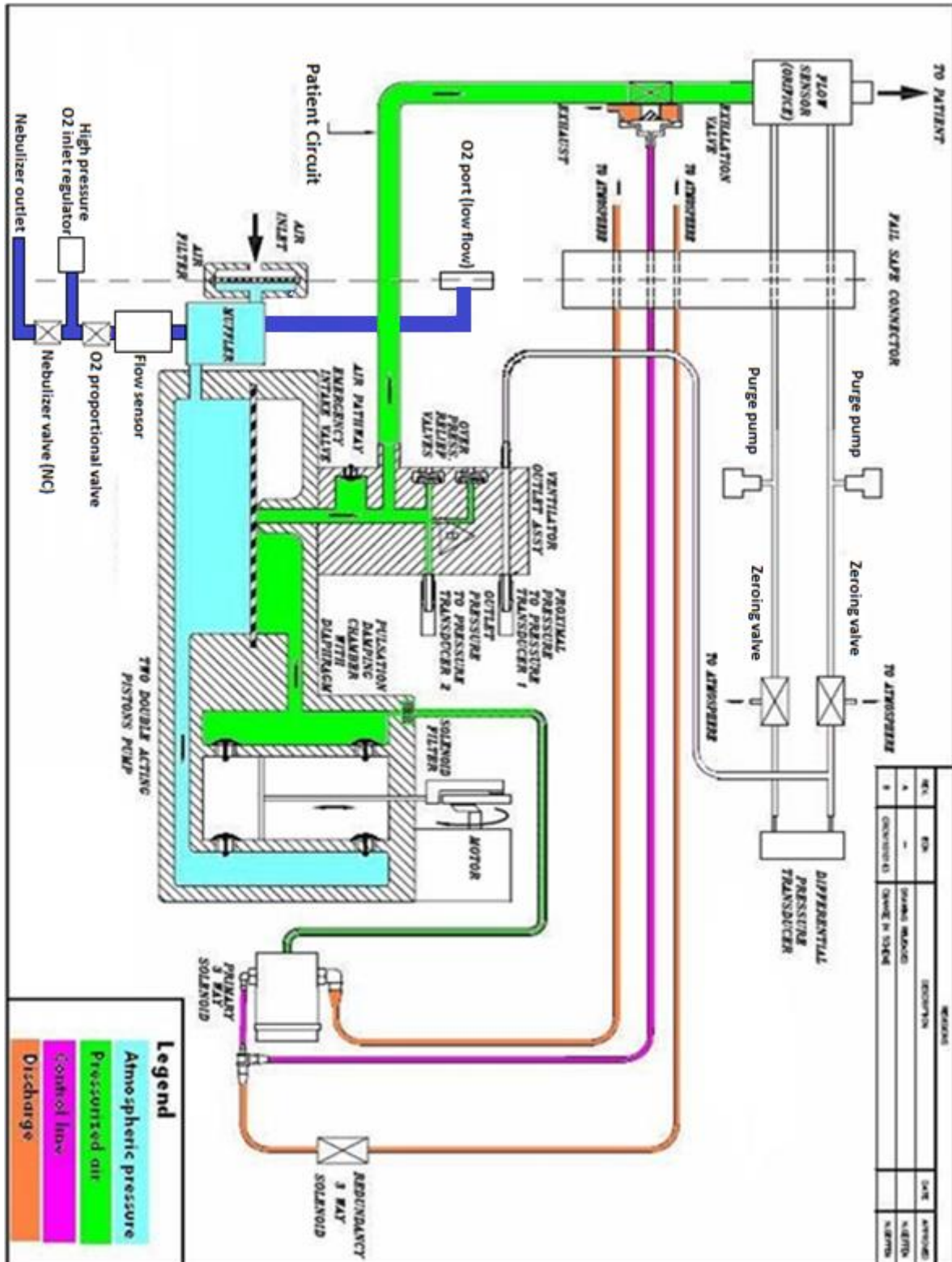

3.10 Electrical Diagram

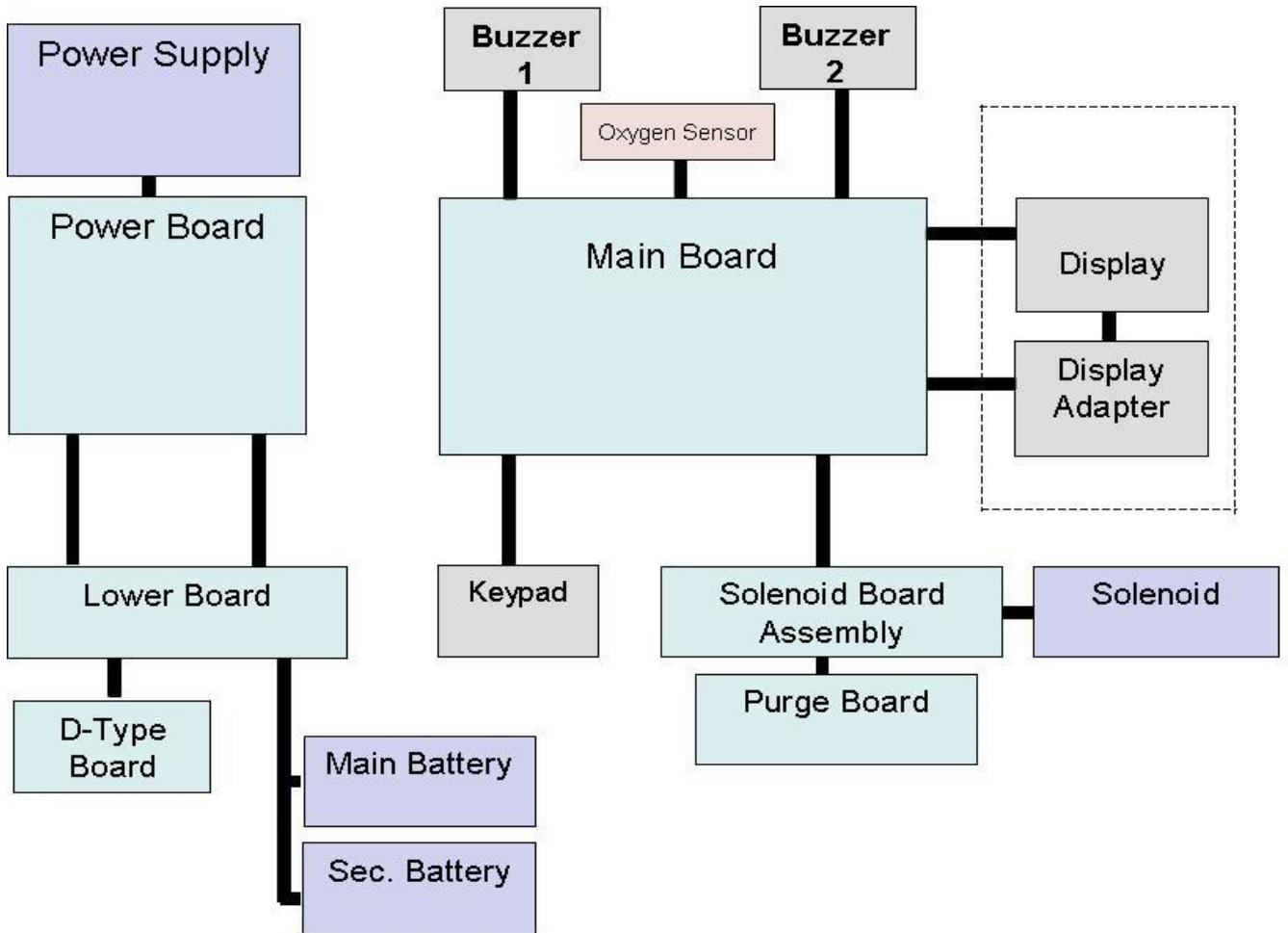

3.11 Electrical Diagram – *iO₂ Internal Mixer model*

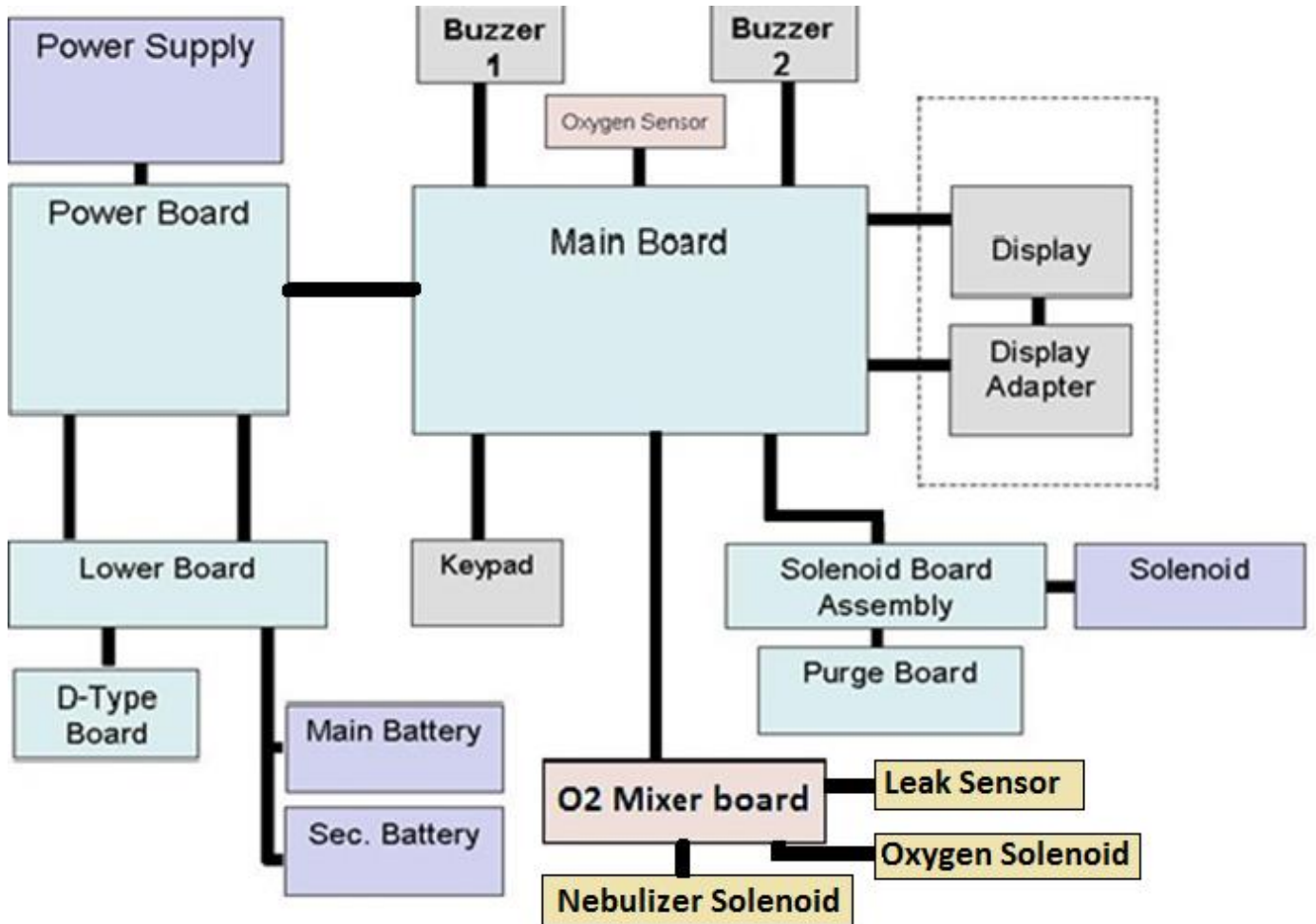

4 Removing and Reinstalling Modules

4.1 Introduction

This chapter provides detailed procedures on how to remove FLIGHT 60 Ventilator modules and assemblies that you suspect are worn, damaged, or performing improperly, and how to install new or repaired modules and assemblies.

Make sure you are familiar with the FLIGHT 60 Ventilator's operation before attempting any service or maintenance.



Ventilator log files must be downloaded prior to any service attempt. Refer to the Maintenance chapter for instructions.



Hazardous voltages are present inside the ventilator. Disconnect electrical power and oxygen sources before attempting any disassembly. Remove watch and any jewelry. Failure to do so may result in injury to service personnel or damage to the ventilator.

4.2 Required Equipment

The following equipment is required to remove and replace FLIGHT 60 ventilator modules:

- Antistatic wrist strap
- Phillips screwdriver PH1
- Flat screwdriver 0.8x4
- Torx screwdriver BT10x200
- Cutter
- Cable ties: PLT1M-M69; PLT4S-M69



To protect external parts and the touch screen from any damage while in contact with the working surface, place the ventilator on a cushioned surface while it is being serviced.



After servicing the ventilator modules, refer to the Test Table in the Operational Verification Procedure (OVP) chapter and perform the necessary Operation Verification Tests.

4.3 Replacing the Detachable Battery



Single battery configuration ventilators are not equipped with a detachable battery.

4.3.1 Removing the Detachable Battery

➔ To remove the detachable battery:

1. Turn the lock dial counterclockwise, in the direction of the OPEN arrow.



Figure 8 – Removing the Detachable (Main) Battery

2. Pull the battery out of the ventilator.

4.3.2 Installing the Detachable Battery

➔ To install the detachable battery:

1. Insert the detachable battery into the ventilator.
2. Turn the lock dial clockwise, in the direction of the CLOSE arrow, until it is firmly locked.

4.4 Replacing the Internal Battery

4.4.1 Removing the Internal Battery

➔ To remove the internal battery:

1. Remove the four Phillips screws that secure the battery panel to the bottom panel.



Figure 9 – Removing the Internal Battery Panel

2. Remove the internal batteries from the battery compartment.

4.4.2 Installing the Internal Battery

- ➔ To install the internal battery:
 - Follow the above procedure in reverse order.

4.5 Removing the Ventilator Cover

4.5.1 Removing the Ventilator Cover

The following procedure describes how to remove the ventilator cover. In most cases the cover must be removed in order to access the ventilator modules.

- ➔ To remove the ventilator cover:
 1. Remove the two Torx screws inside the ventilator handle.

Removing and Reinstalling Modules

Removing the Ventilator Cover



Figure 10 – Removing Screws Inside Handle

2. Remove the two Torx screws connecting the ventilator cover to the back panel.



Figure 11 – Removing Back Screws

3. Remove the two Torx screws from the bottom panel.

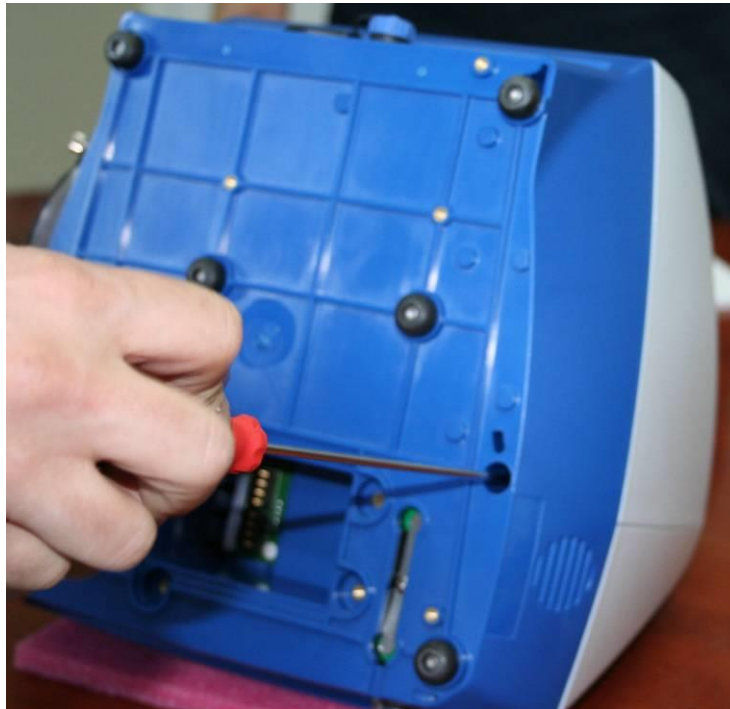

Figure 12 – Removing the Bottom Panel Screws

4. Remove the ventilator cover.

The modules of the ventilator are now exposed and accessible.



Figure 13 – Removing the Ventilator Cover



Cover screws are longer than the rest of the screws used in the ventilator

Replacing the Power Board

4.5.2 Installing the Ventilator Cover

- ➔ To reattach the ventilator cover:
 - Follow the above procedure in reverse order.

4.6 Replacing the Power Board

4.6.1 Removing the Power Board

- ➔ To remove the power board:
 1. Remove the detachable battery (see section 4.3) and the internal battery (see section 4.4).
 2. Remove the ventilator cover (see section 4.5).
 3. Disconnect the flat flex cable P3 from the power board.

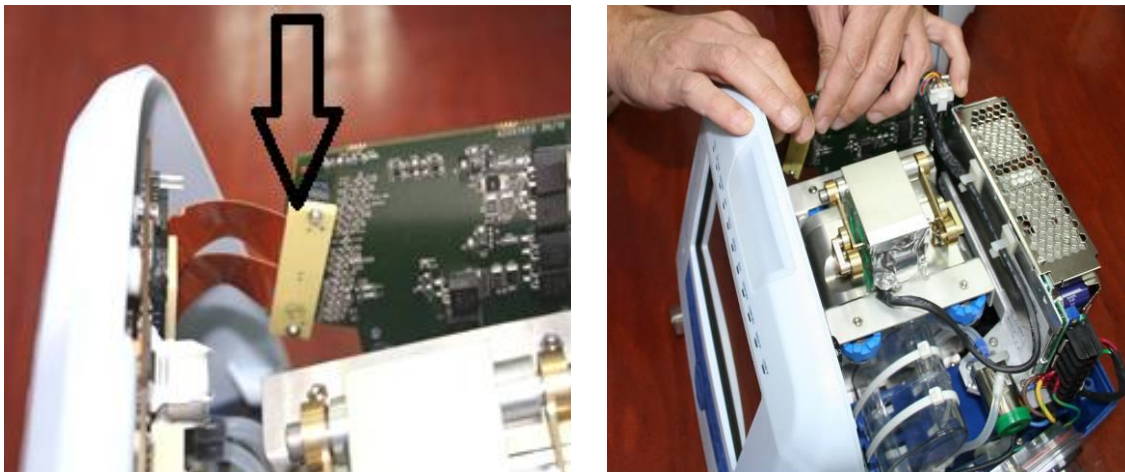

Figure 14 – Disconnecting Flat Flex Cable from Power Board

4. Disconnect the 8-pin P2 manifold cable connector from the power board, by pressing the release tab on the connector.

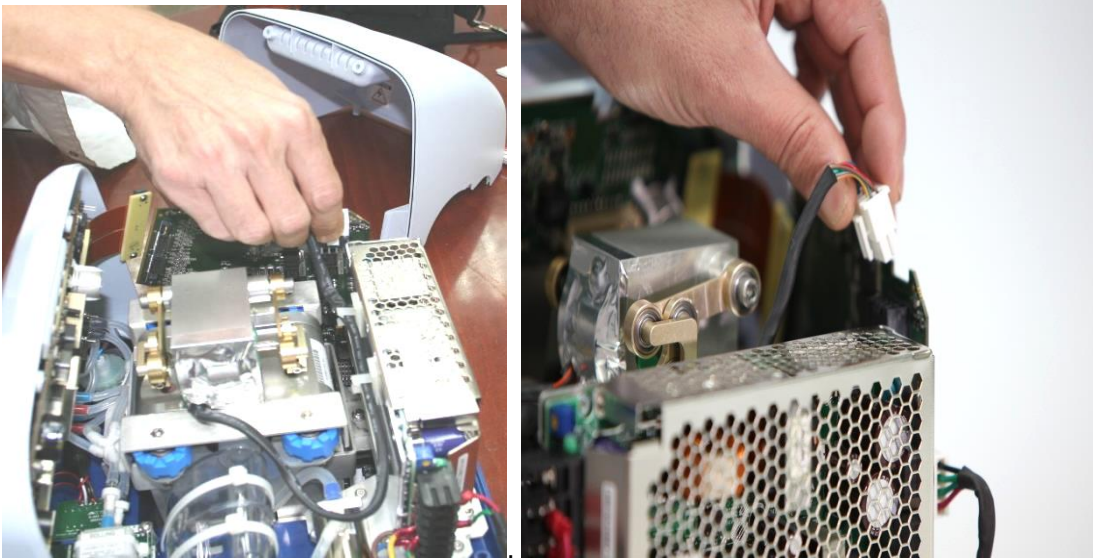

Figure 15 – Disconnecting Manifold Cable Connector P2 from Power Board

5. Disconnect the 4-pin P6 power supply connector from the power board, by pressing the release tab on the connector.

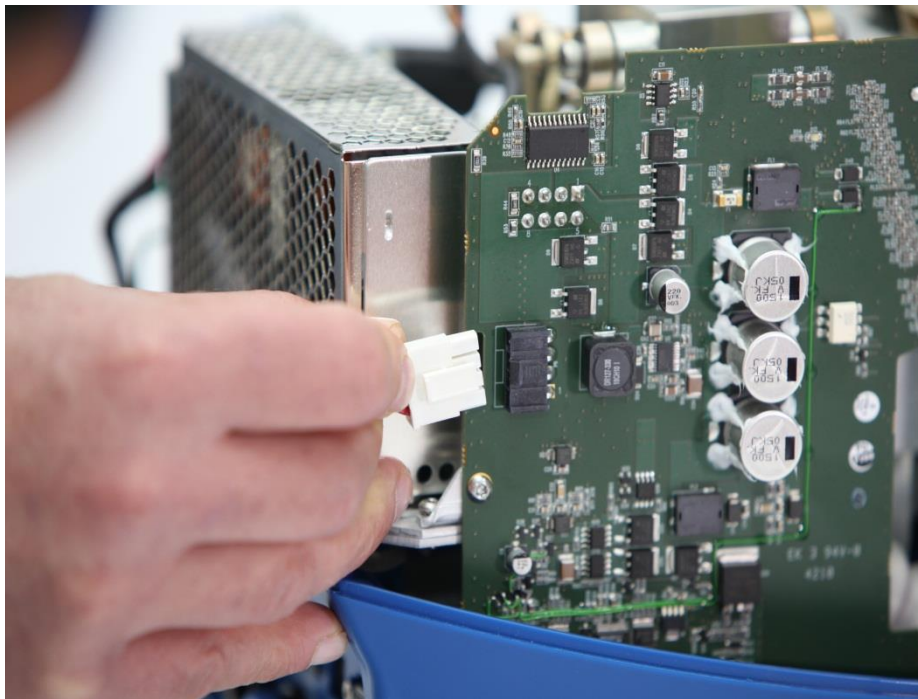

Figure 16 – Removing Power Supply Connector P6 from Power Board

6. Remove the Torx screw connecting the power board to its bracket.

Removing and Reinstalling Modules

Replacing the Power Board

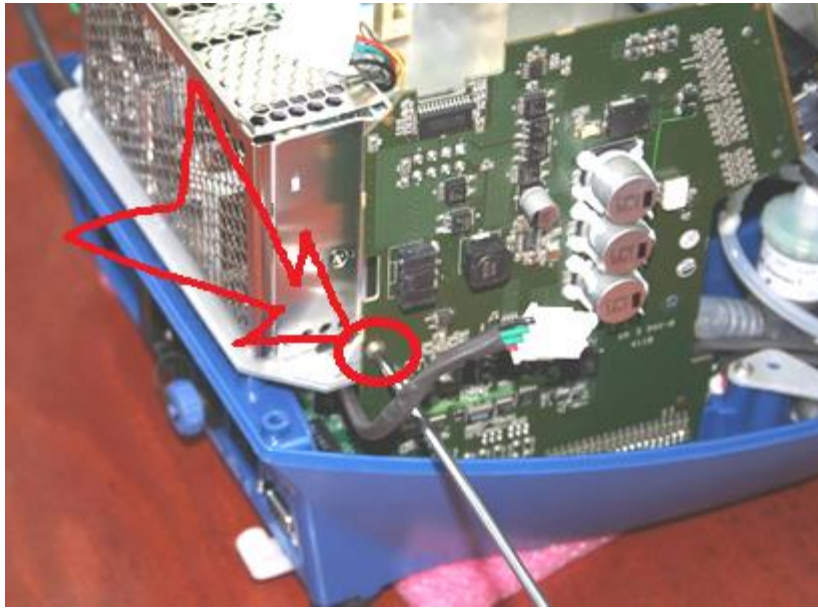

Figure 17 – Removing Screw Connecting Power Board to Power Board Bracket



Do not hold the power board by its components. To pull the board out, hold the grooves. Refer to the figure below for correct positioning.

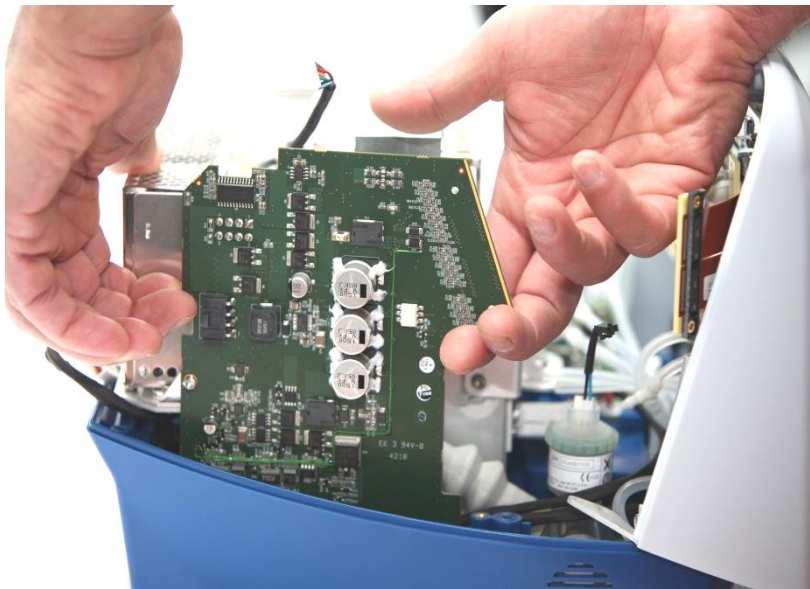

Figure 18 – Lifting Power Board from Ventilator Base

7. Holding the board by the grooves, carefully pull the board out by lifting up slightly on one side and then the other, continuing to alternate sides until the board is released from the socket.

4.6.2 Installing the Power Board

➔ To install the power board:

1. Check that the power board sockets do not have any bent pins.
2. Slide the power board through the right and left guide tracks, positioning the power board connectors over the sockets.

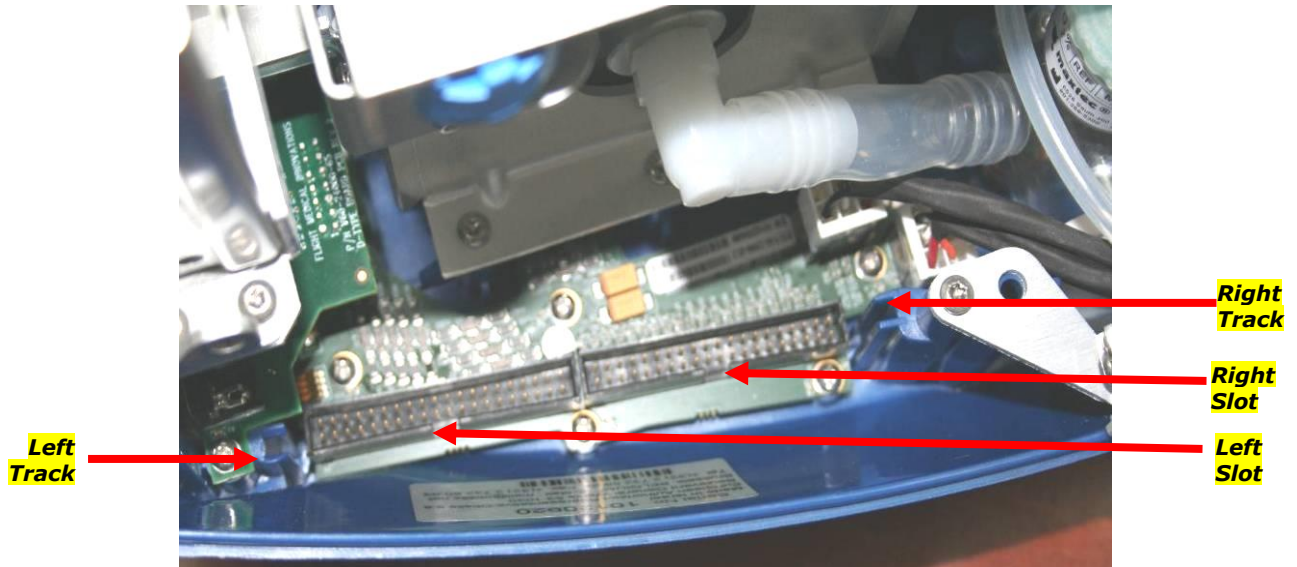

Figure 19 – Power Board Slots and Tracks

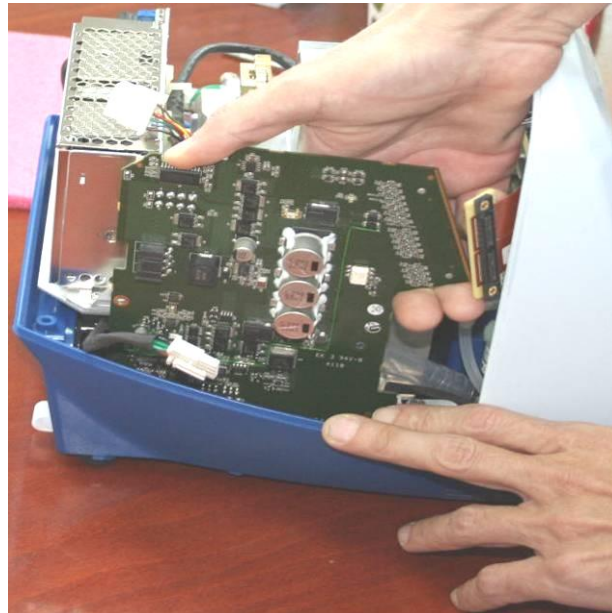

Figure 20 – Inserting Power Board into Ventilator Base

3. Firmly push down the power board, making sure that the power board connectors fit well into the sockets (pin headers) in the base of the ventilator.

Replacing the Power Supply

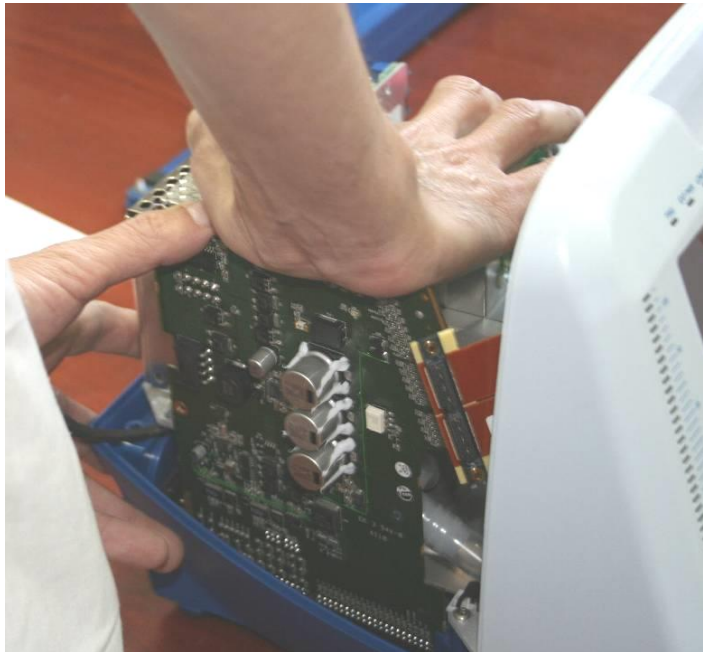

Figure 21 – Pushing Power Board into Ventilator Base

4. Perform steps 1 to 6 of the removal procedure in the reverse order.

4.7 Replacing the Power Supply



The Flight60 has either a Class I or a Class II Power Supply. **The Power Supplies are NOT interchangeable.**

Class I Power Supply is obsolete and cannot be supplied by Flight Medical.

4.7.1 Class I Power Supply



➔ To remove the power supply:

1. Remove the detachable battery (see section 4.3) and the internal battery (see section 4.4).
2. Remove the ventilator cover (see section 4.5).
3. Release the manifold motor cable from the cable clamps on the power supply.

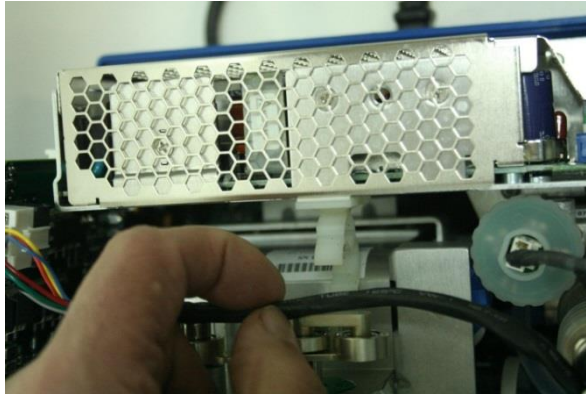

Figure 22 – Releasing the Motor Cable

4. Disconnect the power wiring (total of seven wires) by loosening the Phillips screws.

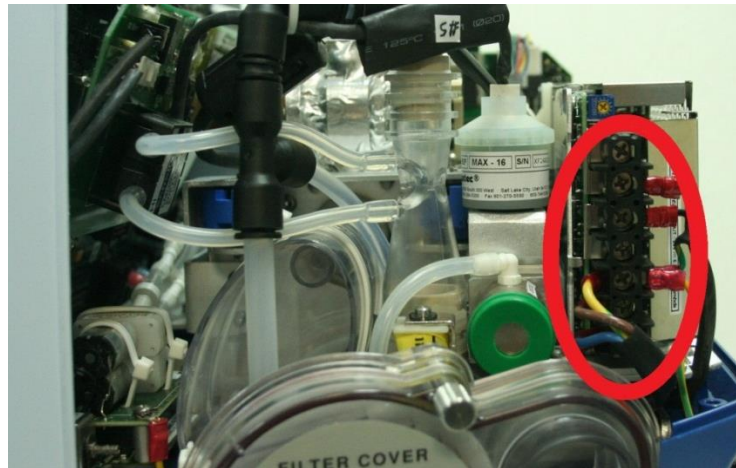

Figure 23 – Power supply Wiring

5. Remove the 4 Torx screws that are securing the power supply bracket (two on each end).



Figure 24 –Power-Supply Bracket screws

Removing and Reinstalling Modules

Replacing the Power Supply

6. Remove the power supply.
7. Detach the power supply from its bracket by unscrewing the three Phillips screws securing the bracket.



Figure 25 – Detaching the Power Supply from Its Bracket

➔ To install the power supply:

- Follow the above procedure in reverse order, paying attention to the following:
- The Power-Supply bracket fits under the power board bracket



Figure 26 – Bracket Positioning

- Be sure not to apply pressure to the solenoid assembly during this procedure
- Connect the wires according to the following diagram:

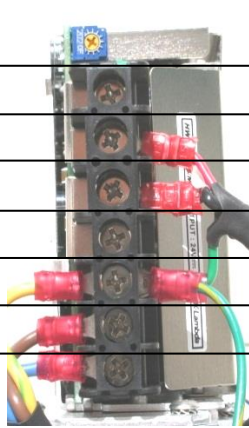
Wire Color	Connection	
-	{unused}	
Red	DC Output +V	
Black	DC Output -V	
-	{unused}	
Yellow; Green; Yellow/green (3 wires)	GND (chassis)	
Brown	AC Input L	
Blue	AC Input N	

- After reconnecting the power wiring, firmly tighten all 7 Phillips screws in the terminal block, including the unused ones.

4.7.2 Class II Power Supply



➔ **To remove the power supply:**

1. Remove the detachable battery (see section 4.3) and the internal battery (see section 4.4).
2. Remove the ventilator cover (see section 4.5).
3. Release the manifold motor cable from the cable clamps on the power supply.
4. Disconnect the 2 cables from the Power Supply:

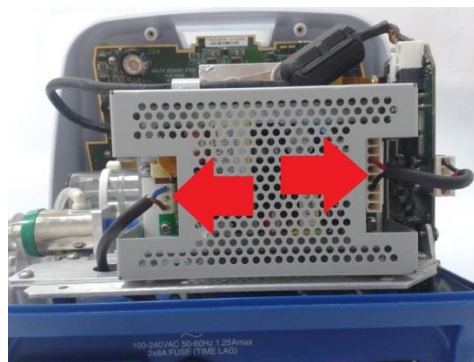

Figure 27 – Power Supply cables



Disconnect the output cable from the Power Board first. Use flat/needle nose pliers to gently pull out the connector from the Power Supply

Removing and Reinstalling Modules

Replacing the Front Panel Assembly

5. Remove the 4 Torx screws securing the bracket



Figure 28 – Securing screws

6. Remove the 4 Philips screws securing the bracket to the Power Supply

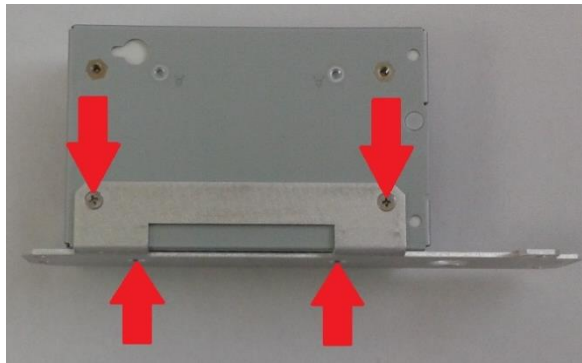

Figure 29 – Detaching the Power Supply from Its Bracket

➔ To install the power supply:

Follow the above procedure in reverse order

4.8 Replacing the Front Panel Assembly

4.8.1 Removing the Front Panel Assembly

➔ To remove the front panel assembly:

1. Remove the detachable battery (see section 4.3) and the internal battery (see section 4.4).
2. Remove the ventilator cover (see section 4.5).
3. Disconnect the flat flex cable P16 from the Main Board.



Figure 30 – Flat Flex Cable going to P16

4. On the underside of the ventilator, unscrew the three Torx screws securing the bottom of the front panel.



Figure 31 – Loosening the Torx Screws Under the Front Panel

5. Remove the Torx screws from the front panel brackets (one on each side). Carefully slide the front panel outwards to allow access to electrical cables and silicon tubes.

Removing and Reinstalling Modules

Replacing the Front Panel Assembly

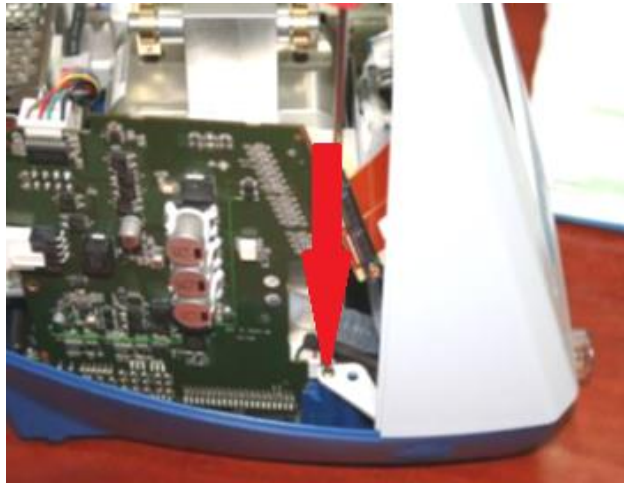

Figure 32 – Torx Screws on Front Panel Bracket

For iO₂ Internal Mixer model

6. Disconnect the 2 silicon tubes from the O₂ mixer neb board.
7. Disconnect the nebulizer cable from the O₂ mixer neb board.
8. Disconnect the mixer cable from the O₂ mixer neb board.
9. Disconnect the O₂ leak sensor cable from the O₂ mixer neb board.

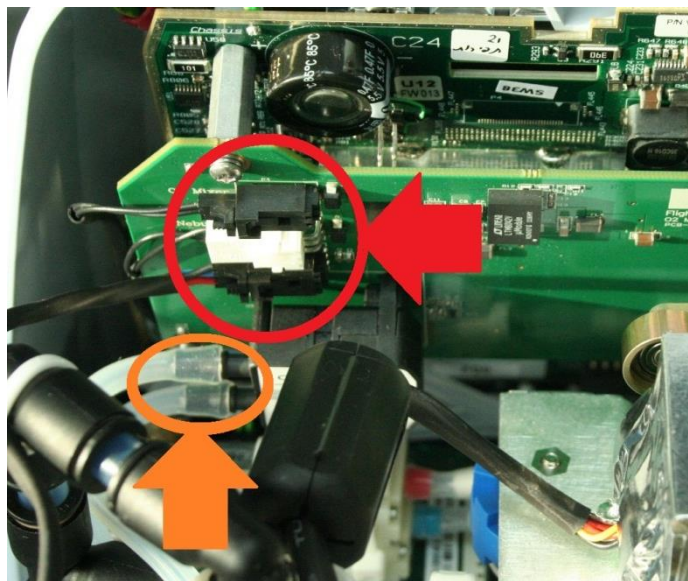

Figure 33 – Disconnecting from O₂ mixer neb board

10. Disconnect the 3 silicon tubes coming from the main board. Note the color coding. Disconnect them from the Y connectors and not from the board itself.
11. Disconnect the solenoid board flat cable.

Replacing the O₂ mixer Neb board * (iO₂ Internal mixer model only)

12. Disconnect the O₂ sensor cable.
13. Remove the front panel from the ventilator.

4.8.2 Connecting the Front Panel Assembly

- ➔ To connect the front panel assembly:
 - Follow the above procedure in reverse order.

4.9 Replacing the O₂ mixer Neb board * (iO₂ Internal mixer model only)

4.9.1 Removing the O₂ mixer neb board

- ➔ To remove the O₂ mixer neb board:
 1. Follow the procedures for removing the front panel assembly (see section 4.8)
 2. remove the 3 screws securing the O₂ mixer Neb board to the Main Board.



Figure 34 – Securing screws

3. Pull the mixer board out of the connector .

4.9.2 Installing the O₂ mixer board

- ➔ To connect the O₂ mixer board:
 - Follow the above procedure in reverse order.

4.10 Replacing the Main Board



Record system S/N, manifold S/N and motor hours prior to replacing the main board. After replacing the board need to update the SW with those numbers, as described in chapter 8.

4.10.1 Removing the Main Board

→ To remove the main board:

1. **For iO_2 internal mixer model** - Follow the procedure for Removing the O_2 mixer neb board (see section 4.9)
2. Remove the 6 Torx screws holding the Main Board to the front panel
3. On the bottom side of the Main Board, disconnect buzzer connectors LS1 and LS2.
4. Disconnect the back light cable from connector P5.



Do not pull the wires. Press the locker and then remove.

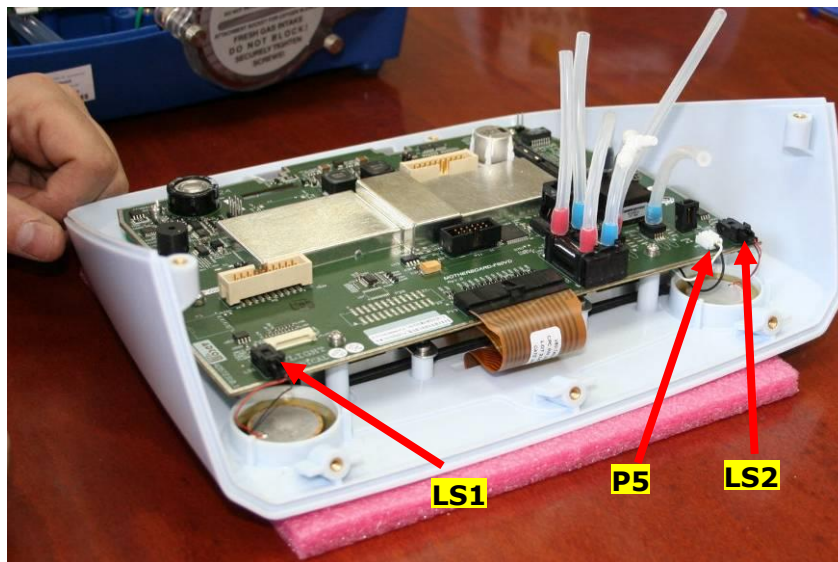

Figure 35 – LS1; LS2; P5 connectors

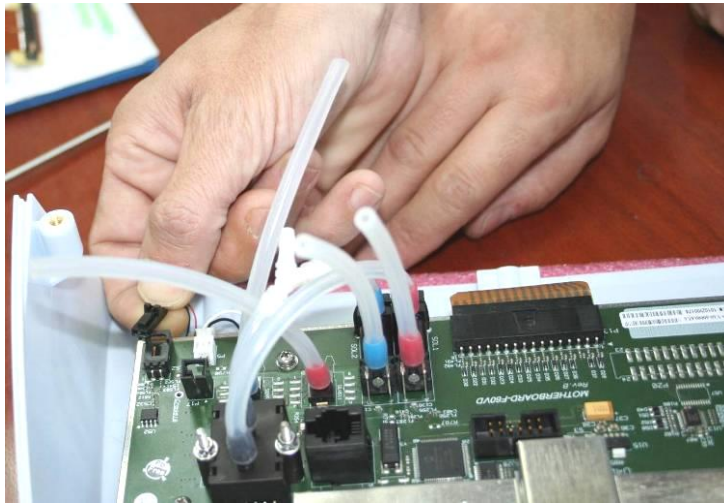

Figure 36 – Disconnecting LS2 connector

5. Disconnect the P13 flat cable by pressing hard on the locker and then pulling it out.

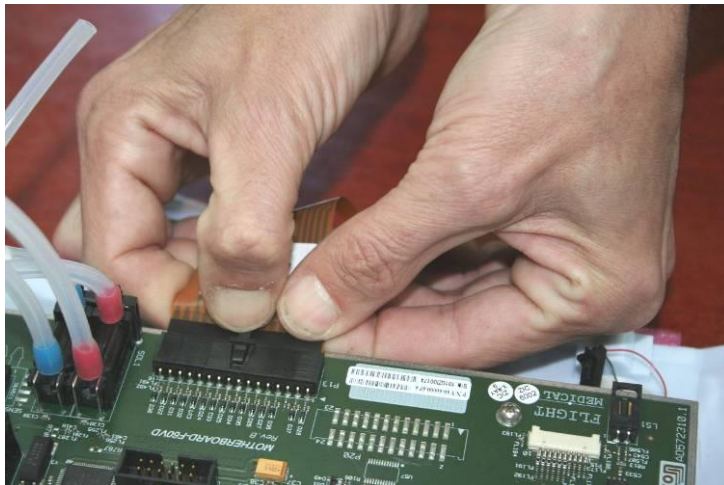

Figure 37 – Disconnecting the P13 Flat Cable

6. Remove the six Philips screws securing the Main Board to the front panel.

Removing and Reinstalling Modules

Replacing the Main Board



Figure 38 – Detaching the Main Board from the Front Panel

7. Remove the grounding screw at the top left of the board.

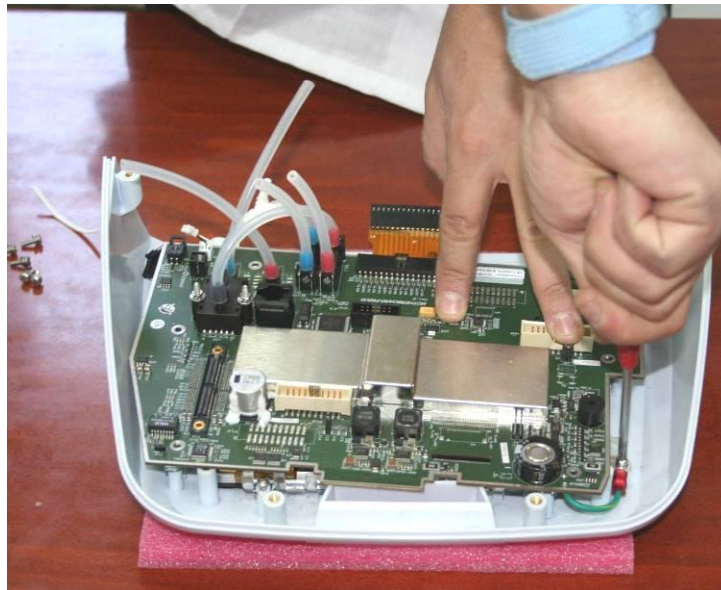

Figure 39 – Detaching the Grounding Screw

8. Lift the Main Board. Carefully detach the flat cables from the connectors on the main board.
9. Remove the J3 flat cable by clicking the locker on the main board and then pulling out the cable.

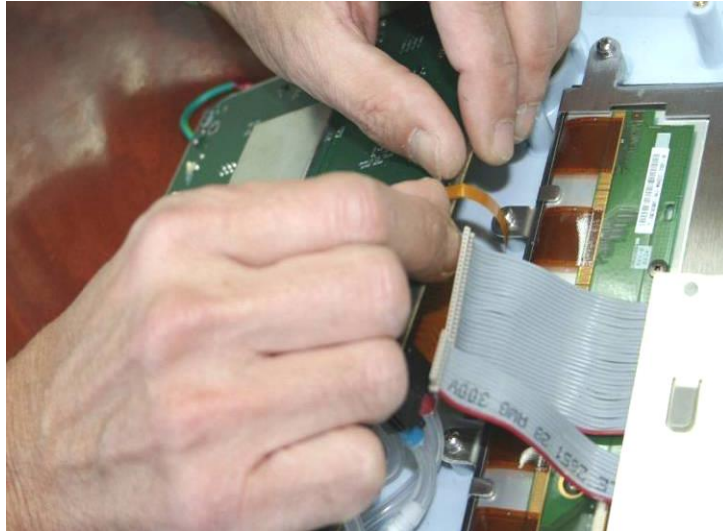

Figure 40 – Removing the J3 Flat Cable

10. Remove the Main Board.



Do not remove the silicon tubes from the main board when it is sent for repair.

4.10.2 Installing the Main Board

➔ **To install the main board:**

1. Check that the main board sockets do not have any bent pins.
2. Perform the removal procedure in the reverse order.

4.11 Replacing the Touch Screen

The touch screen cannot be detached from the front panel; When the touch screen needs replacement , the Front Subassembly (P/N V60-70010-60) is to be replaced

1. Follow the procedures for removing the main board (see section 4.10)
2. Replace the front Subassembly

➔ **To reassemble the touch screen:**

- Perform the above procedure in reverse order.

4.12 Replacing the Manifold Assembly

4.12.1 Removing the Manifold Assembly

➔ To remove the manifold assembly:

1. Remove the detachable battery (see section 4.3) and the internal battery (see section 4.4).
2. Remove the ventilator cover (see section 4.5).
3. Remove the front panel assembly (see section 4.8)
4. Remove the Power board (see section 4.6)
5. Remove the two Torx screws securing the inlet assembly.

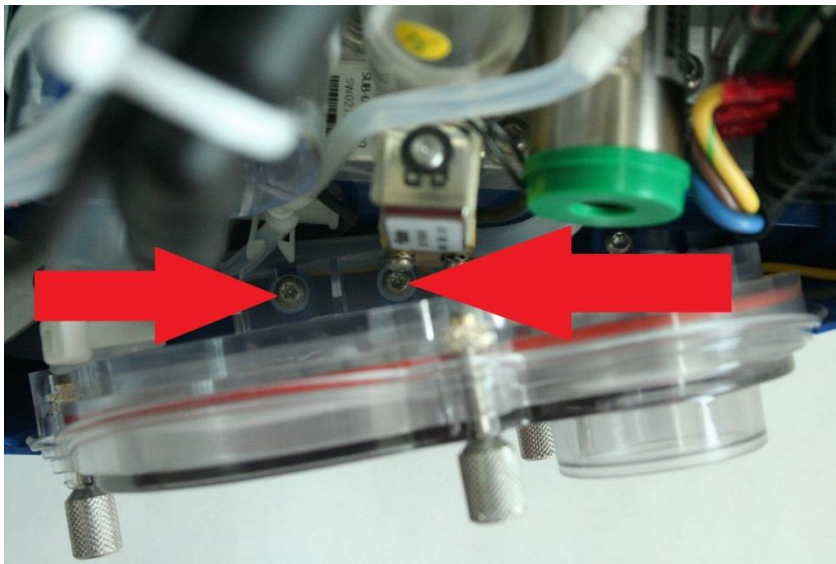

Figure 41 –Inlet assembly screws

6. Disconnect the Oxygen hose from the inlet assembly



Figure 42 – Low Flow O₂ hose

7. Disconnect the inlet assembly from the flex tube by pulling out the tube.

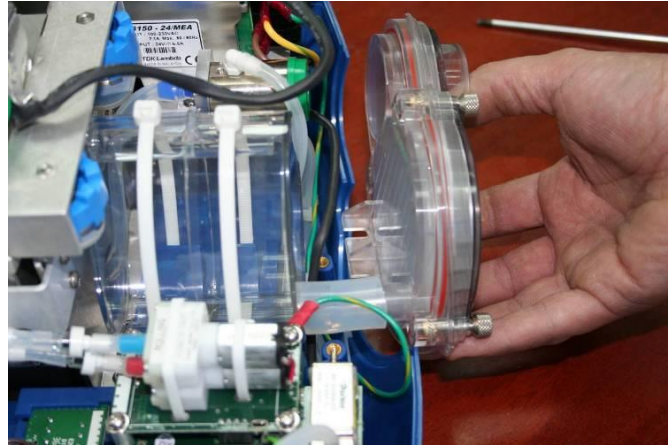

Figure 43 - Pulling out the Flex Tube

8. Disconnect the O₂ Mixer hose from the muffler
9. Cut the cable ties securing the muffler.



Figure 44 - Cutting the Cable Ties

10. **For iO₂ model** - Disconnect the vertical silicon tube from the muffler

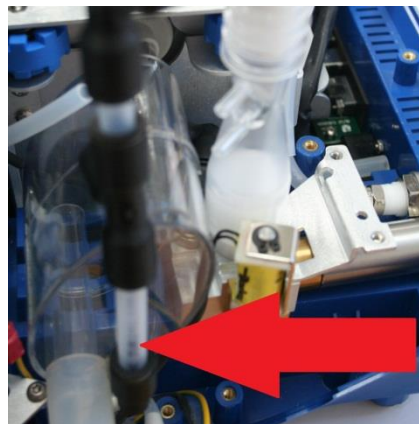

Figure 45 - Silicon tube

Removing and Reinstalling Modules

Replacing the Manifold Assembly

11. Gently pull the muffler out of the short flex tube, and put it aside.

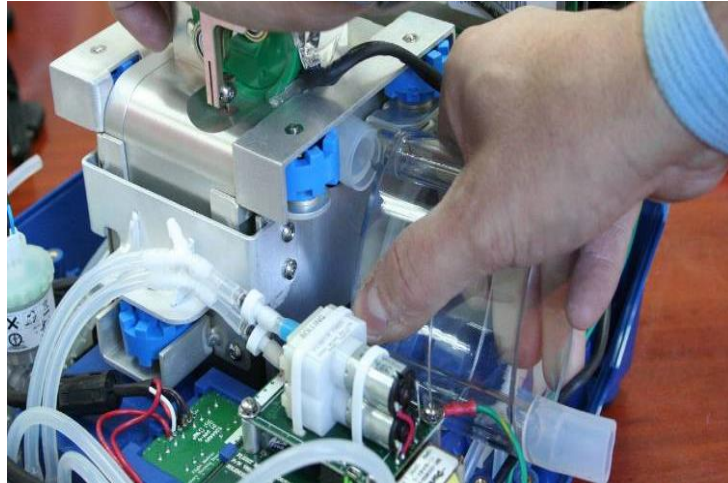

Figure 46 – Removing the Muffler

12. Disconnect the flex tube between the manifold and the outlet assembly.

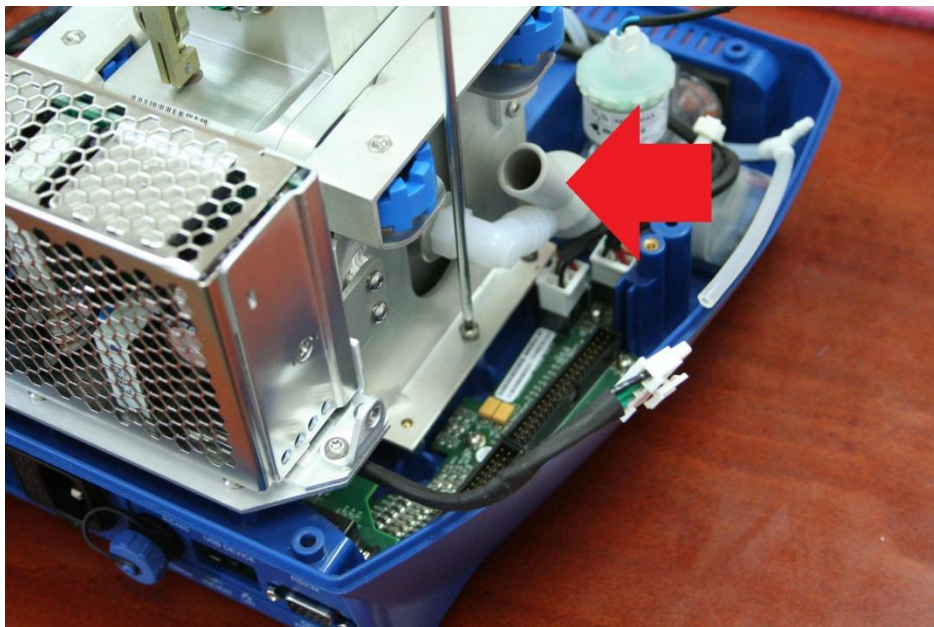

Figure 47 – Flex tube

13. Disconnect the silicon tubes from the solenoid.

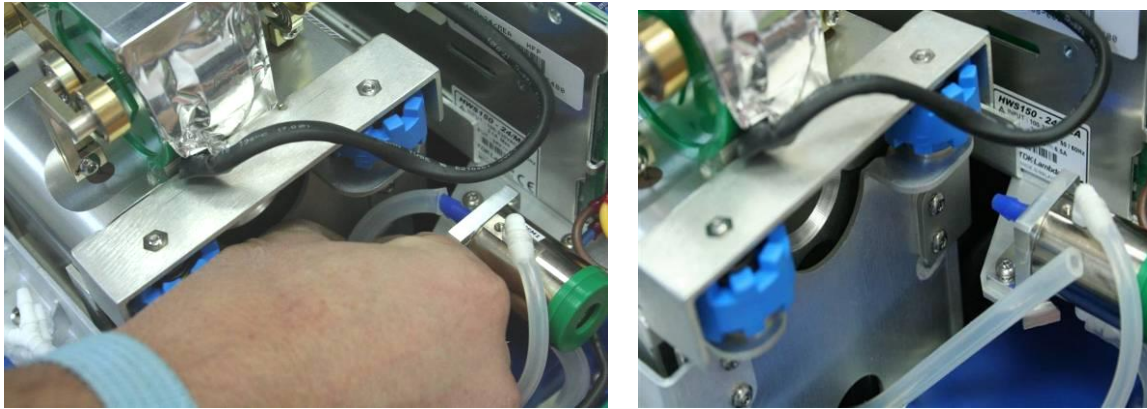

Figure 48 – Disconnecting the Flex Tubes

14. Release the Manifold power cord from the wire saddles.

15. Remove the six Torx screws from the manifold base (three on each side).



Figure 49 – Detaching the Manifold Base

16. Carefully lift out the manifold assembly.



Don't apply any force on the piston drive mechanism. Don't hold the manifold by the bearings or by the metal rods.

Replacing the Manifold Assembly

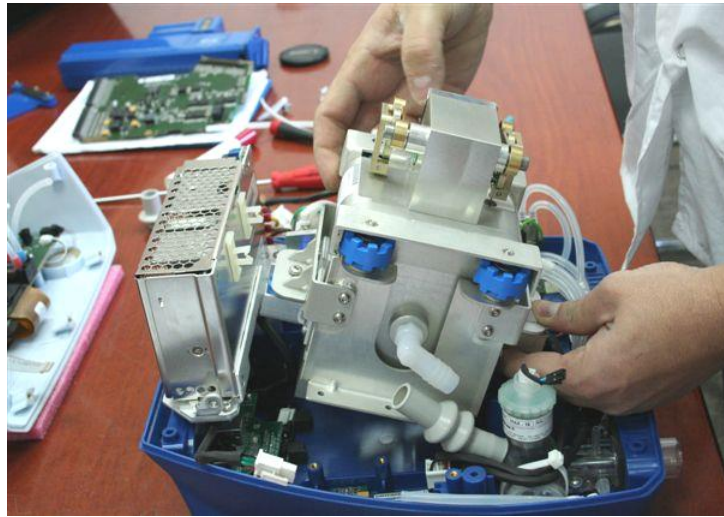

Figure 50 – Removing the Manifold Assembly



The vibration dumping frame is an integral part of the manifold and should not be disassembled from the manifold.



Before sending the manifold assembly to FLIGHT MEDICAL, **remove the short and long flex tubing.**

4.12.2 Installing the Manifold Assembly

→ To install a manifold assembly:

- Perform the removal procedure in the reverse order, with the following additional step after inserting the muffler assembly, which is helpful for getting the cable ties through their slots:
- Insert the detachable battery until it is almost completely in, and then assemble the cable ties through the slots under the muffler.
- If a new manifold was installed, run PCS downloader to update the manifold serial number and reset working hours. See section 5.2.

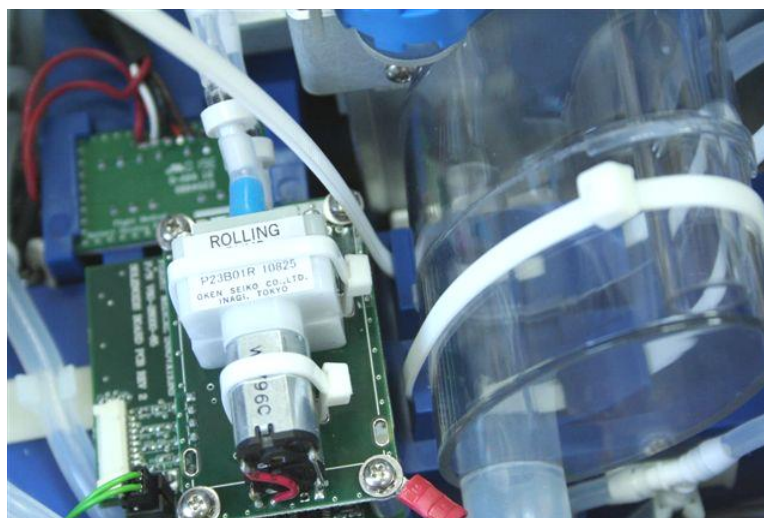

Figure 51 – Assembling Cable Ties

4.13 Replacing the Oxygen Sensor



Not applicable for ventilators without an Oxygen sensor.



Refer to Flight Medical Service Notes for a list of approved Oxygen sensors

4.13.1 Removing the Oxygen Sensor

➔ **To remove the oxygen sensor:**

1. Remove the detachable battery (see section 4.3) and the internal battery (see section 4.4).
2. Remove the ventilator cover (see section 4.5).
3. Remove the front panel (see section 4.8).
4. Disconnect the electrical cable from the oxygen sensor.



Figure 52 – Removing the Oxygen Sensor

5. Turn the oxygen sensor counterclockwise until it comes out.

4.13.2 Installing the Oxygen Sensor

- ➔ To install the oxygen sensor:
 - Follow the above procedure in reverse order.

4.14 Replacing the O₂ leak sensor * (*iO₂ Internal mixer model only*)

4.14.1 Removing the O₂ leak sensor

- ➔ To remove the O₂ leak sensor:
 1. Remove the ventilator cover (see section 4.5).
 2. Disconnect the electrical cable from the O₂ leak sensor.
 3. Turn the O₂ leak sensor counterclockwise until it comes out.

4.14.2 Installing the O₂ leak sensor

- ➔ To install the oxygen sensor:
 - Follow the above procedure in reverse order.

4.15 Replacing the Oxygen mixer * (iO₂ Internal mixer model only)

4.15.1 Removing the Oxygen mixer

➔ To remove the oxygen mixer:

1. Remove the detachable battery (see section 4.3) and the internal battery (see section 4.4).
2. Remove the ventilator cover (see section 4.5).
3. Remove the Power Supply and the power supply base plate + the solenoid (see section 4.7).
4. Remove the muffler.
5. Remove the O₂ leak sensor
6. Remove the 2 silicon tubes and disconnect the Nebulizer & O₂ Mixer cables from the O₂ mixer Neb board

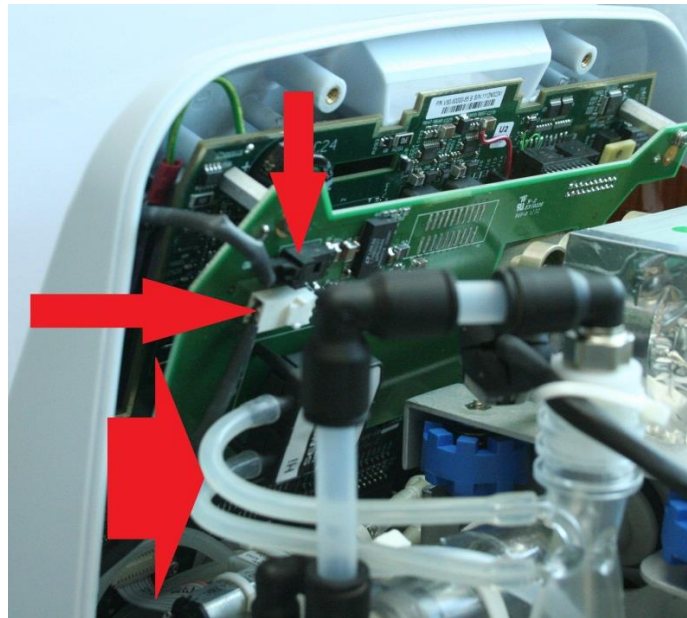

Figure 53 – Electronic connectors and silicon tubes

7. Gently pull out the O₂ mixer

Removing and Reinstalling Modules

Replacing the Oxygen mixer * (iO2 Internal mixer model only)

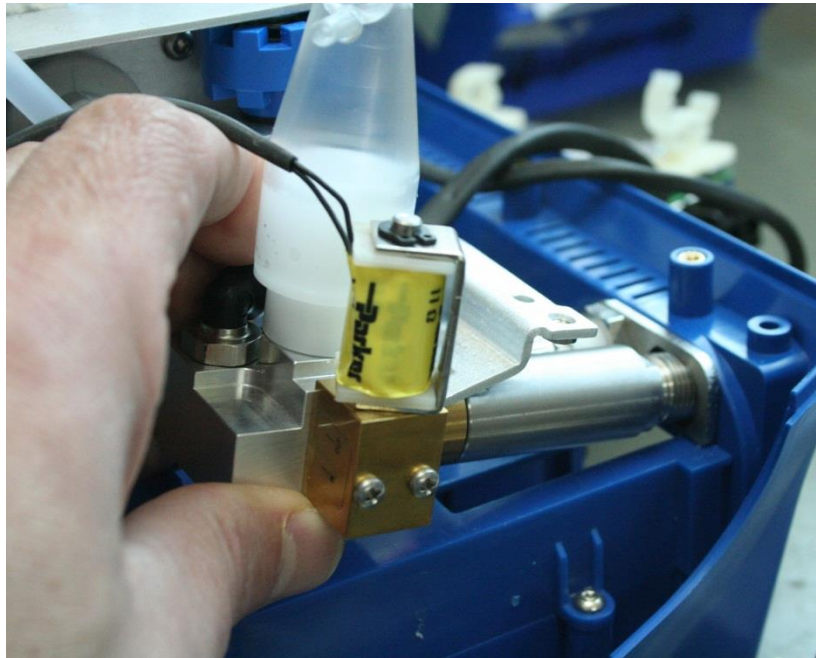

Figure 54 – Pulling out the mixer

4.15.2 Installing the Oxygen mixer

- ➔ To install the oxygen mixer:
 - Follow the above procedure in reverse order. Make sure the flat surface of the mixer is aligned with the metal bracket.

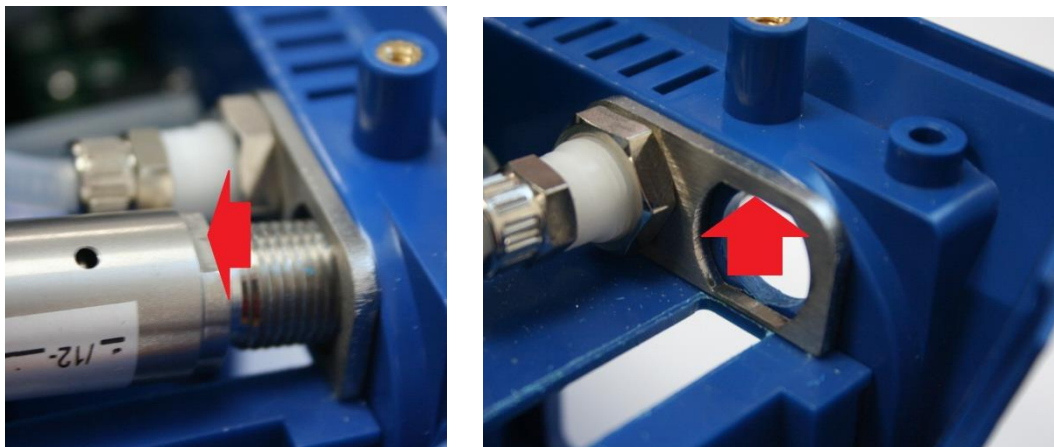

Figure 55 – Mixer orientation

4.16 Replacing the O₂ mixer filters * (iO₂ Internal mixer model only)

To replace the filters:

1. Use twizers to remove the O-ring that secures the filters
2. Use the twizers to pull out the filters (2 each)
3. Place the new filters (2 each) at the O₂ input and push all the way in
4. Push the O-ring in, verify it's in the groove, securing the filters in place

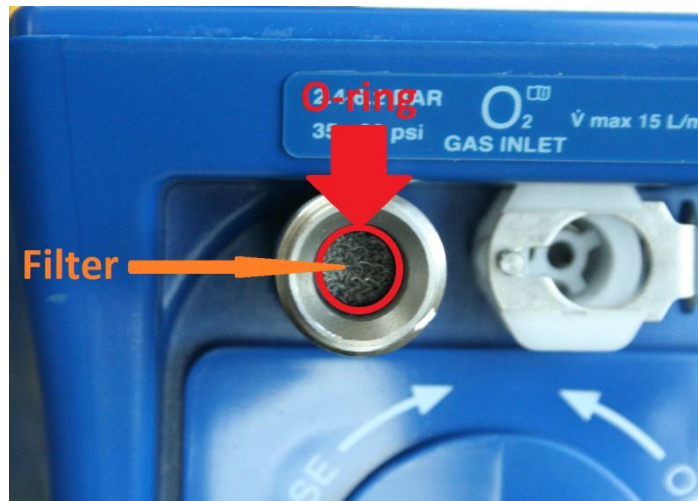

Figure 56 – O₂ regulator filter

4.17 Replacing the Purge Board Assembly

4.17.1 Removing the Purge Board Assembly

➔ To remove the purge board assembly:

1. Remove the detachable battery (see section 4.3) and the internal battery (see section 4.4).
2. Remove the ventilator cover (see section 4.5).
3. Remove the front panel (see section 4.8).
4. Disconnect the two check valves at the ends of the silicon tubes from the purge board.

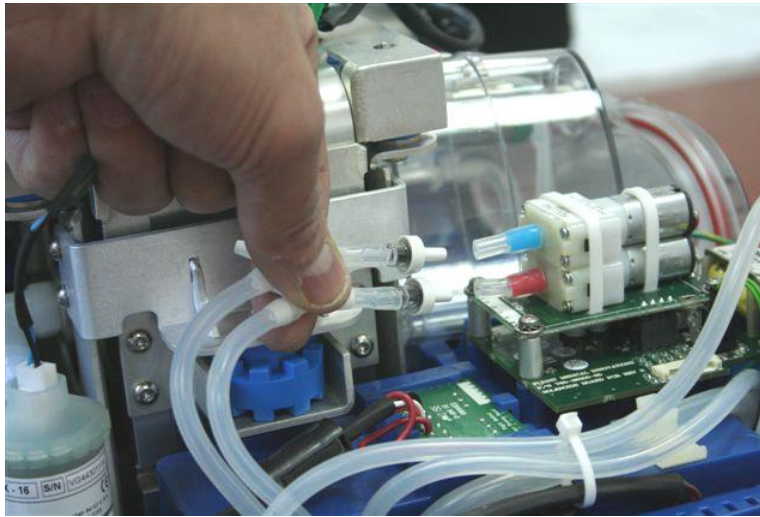

Figure 57 – Disconnecting the Check Valves

5. Remove the four Philips screws (star washers and flat washers) from the purge board. Carefully remove the stand-offs between the purge board and the solenoid board.
6. Carefully separate (pull out) the purge board from the connector on the solenoid board.

4.17.2 Installing the Purge Board Assembly

- ➔ To install the purge board assembly:
 - Follow the above procedure in reverse order.

4.18 Replacing the Solenoid Board Assembly

4.18.1 Removing the Solenoid Board Assembly

- ➔ To remove the solenoid board assembly:
 1. Remove the detachable battery (see section 4.3) and the internal battery (see section 4.4).
 2. Remove the ventilator cover (see section 4.5).
 3. Remove the front panel (see section 4.8).
 4. Remove the purge board (see section 0).
 5. Disconnect connector P1 and the flat cable from the solenoid board.

Removing and Reinstalling Modules

Replacing the Solenoid Assembly

3. Connect the silicon tube attached to the female connector to the inner fitting on the redundancy solenoid.
4. Using the other silicon tube, connect the Solenoid assembly to the outer fitting on the redundancy solenoid.

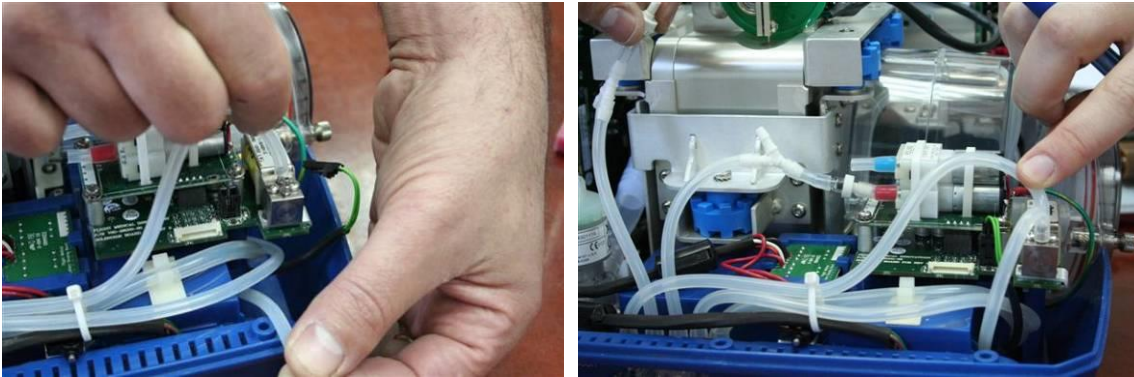

Figure 60 – Connecting the Silicon Tubes

4.19 Replacing the Solenoid Assembly

4.19.1 Removing the Solenoid Assembly

→ To remove the solenoid assembly:

1. Remove the ventilator cover.
2. **For iO_2 internal mixer model** - Remove the O_2 leak sensor.
3. Remove the 2 screws securing the O_2 leak sensor bracket. Remove the bracket.

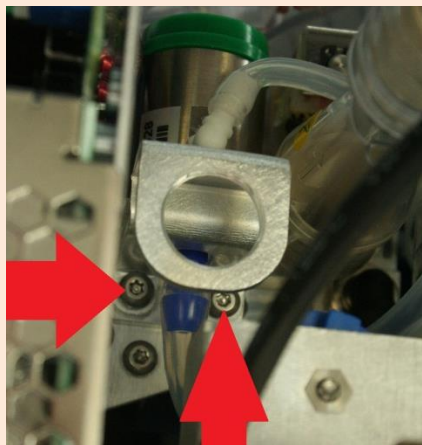

Figure 61 – Remove O_2 leak sensor bracket

4. Disconnect the solenoid cable from the solenoid board (P1). If it's hard to reach you can remove the screws that secure the front panel and move the front panel so gain better access.

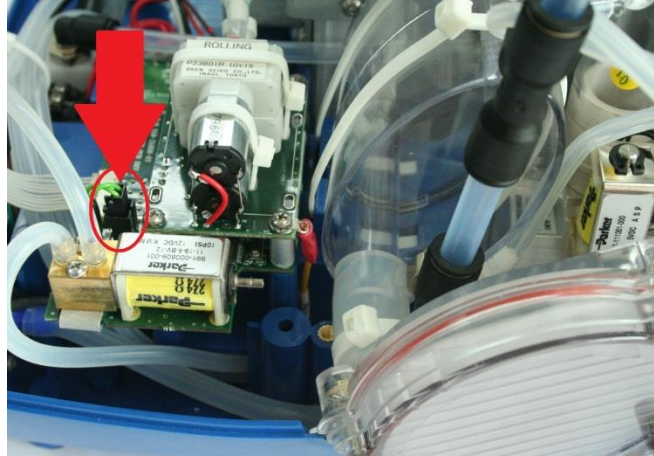

Figure 62 – Solenoid Cable connector

5. Disconnect the 3 silicon tubes from the solenoid assembly.

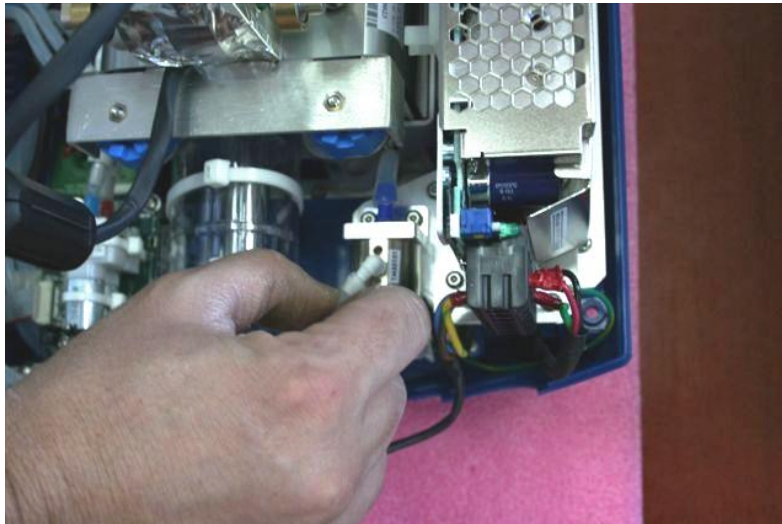

Figure 63 – Disconnecting Silicon Tubes

6. Unscrew the two adjacent Torx screws on the solenoid bracket. Pull out the bracket with the solenoid, carefully leading the solenoid cable, making sure it is not being damaged

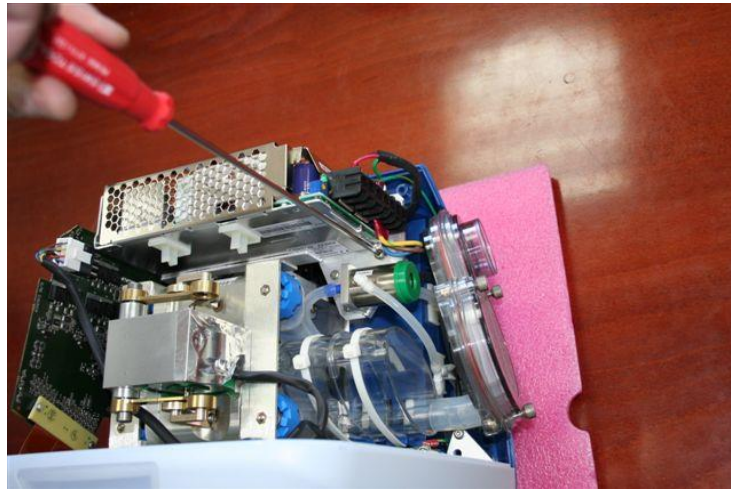

Figure 64 – Detaching the Solenoid Bracket

7. Remove the 2 screws securing the solenoid to the bracket. Pull out the solenoid from the bracket. Verify the sealant O-ring is removed and is not attached to the bracket.

4.19.2 Installing the Solenoid Assembly

- ➔ To install the solenoid assembly:
 - Follow the above procedure in reverse order.

4.20 Replacing the Lower Board and D-type Board

4.20.1 Removing the Lower Board and D-type Board

- ➔ To remove the Lower and D-type boards:
 1. Remove the detachable battery (see section 4.3) and the internal battery (see section 4.4).
 2. Remove the ventilator cover (see section 4.5).
 3. Remove the front panel assembly (see section 4.8).
 4. Remove the Power board (see section 4.6)
 5. Remove the Power Supply and its base plate (see section 4.7)
 6. Remove the internal O₂ mixer (see section 4.15)
 7. Remove the Manifold assembly (see section 4.11)
 9. Unscrew the 2 Torx screws (plastic washers) securing the Outlet assembly. Remove the Outlet assembly.

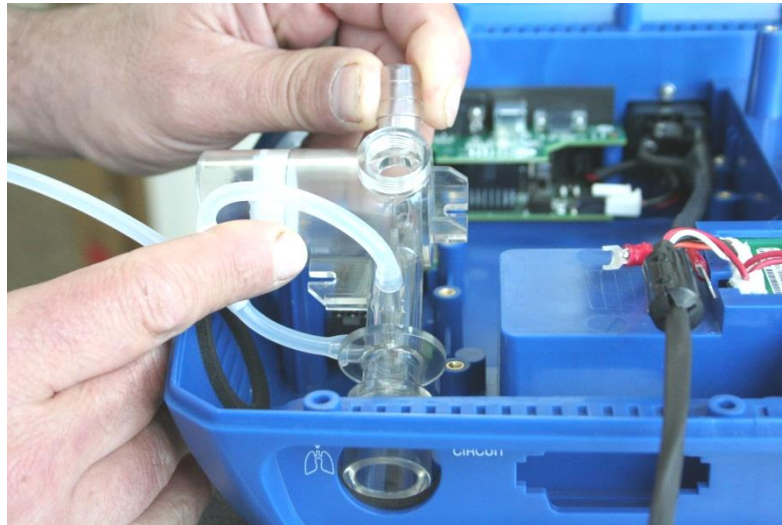

Figure 65 – Removing the Outlet assembly

10. Disconnect connectors P5, P6 and P7 from the lower board

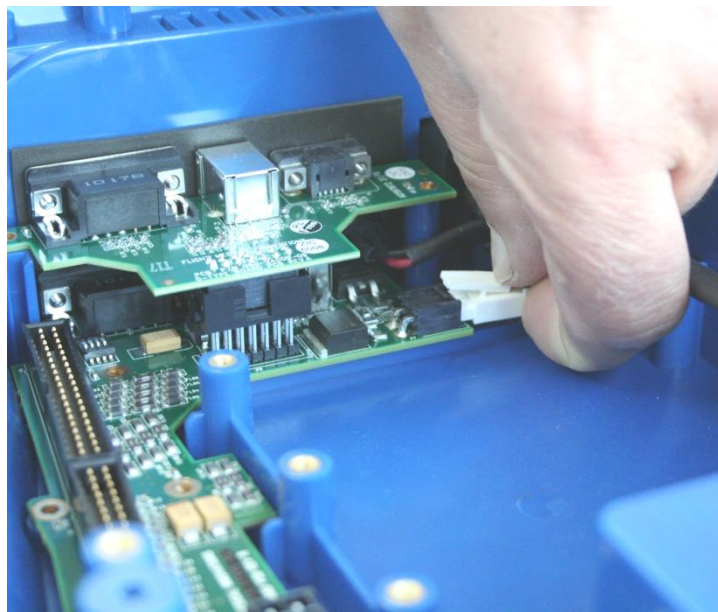

Figure 66 – Disconnecting P7 connector

11. Unscrew the 6 Philips screws securing the lower board and 2 Philips screws securing the D-type board
12. Gently lift the back side of the lower board and pull the lower board with D-type board out of the ventilator base

Removing and Reinstalling Modules

Replacing the Lower Board and D-type Board



Figure 67 – Removing the Lower Board and D-type Board

13. Disconnect the D-type board from the Lower board

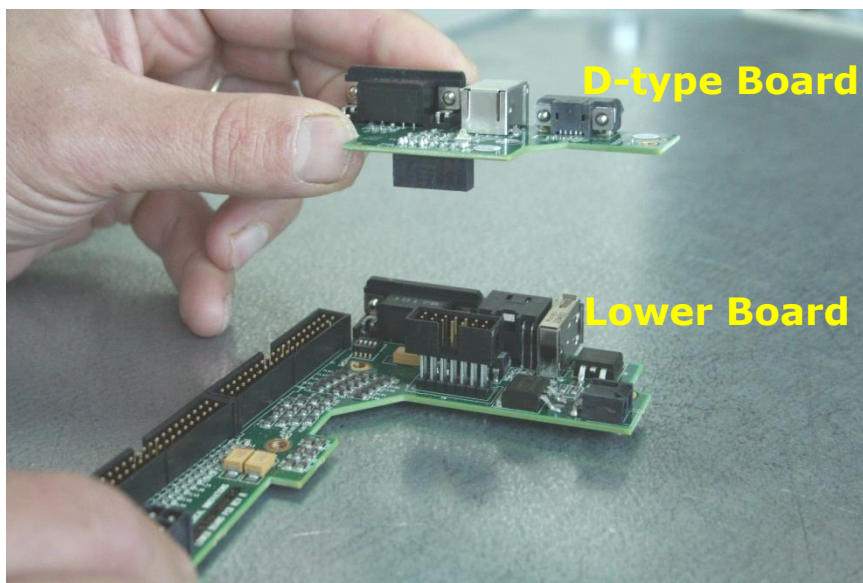

Figure 68 – D-type and Lower boards

4.20.2 Installing the Lower Board and D-type Board

- ➔ To install the Lower and D-type boards:
 - Follow the above procedure in reverse order.

4.21 Replacing the Fuse

The fuse does not need regularly-scheduled servicing. Servicing is required only in case of a problem.

4.21.1 Removing the Fuse

➔ **To remove the fuse:**

1. Pull out the plastic fuse housing at the back of the device with the aid of a flat screwdriver.

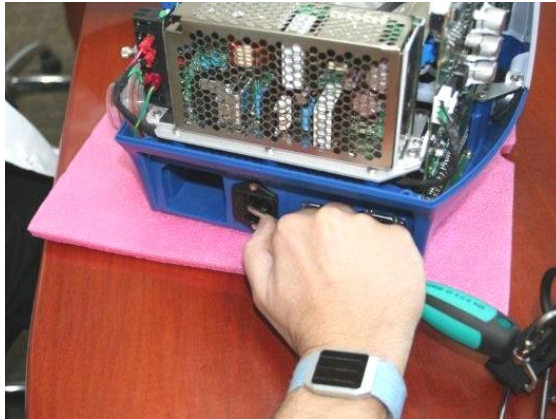

Figure 69 – Removing the Fuse

4.21.2 Installing the Fuse

➔ **To install the fuse:**

Reposition the fuse housing (flat edge on the left) and press firmly to make sure that it is inserted completely.



Figure 70 – Connecting the Fuse

4.22 Replacing the Rubber Bumpers

The six bumpers on the underside of the device do not need regularly-scheduled servicing. Servicing is required only in case of a problem.

4.22.1 Removing the Rubber Bumpers

➔ To remove bumpers:

1. Use a Torx screwdriver to remove bumpers as needed.



Figure 71 – Removing a Rubber Bumper



4.22.2 Installing the Rubber Bumpers

➔ To install a bumper:

Use a Torx screwdriver to attach the bumper and verify that it is fastened securely.

5 Service/Technical Menu

➔ To enter the Service/Technical menu:

1. Press **Technical** / 
2. Press **ADVANCED Screen**.
3. Enter the code **5844**, and confirm by pressing 

5.1 Advanced Screen

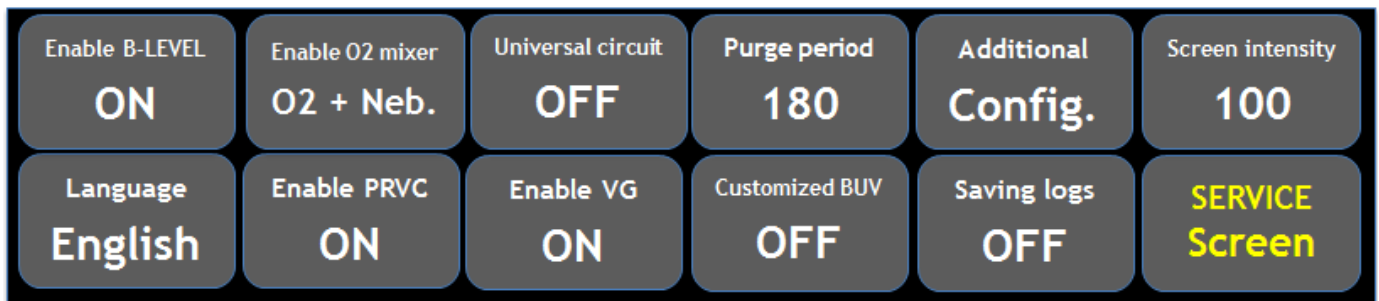

Button	Options	Description
Enable B-LEVEL	ON/OFF	Enable/Disable B-LEVEL ventilation mode
Enable O2 mixer	O2 Only O2+Neb. OFF	Nebulizer is disabled Mixer + Nebulizer
Universal Circuit	ON/OFF	Flow sensor less patient circuit (flow sensor is Integrated in the DL exhalation valve)
Purge Period	60-300 operation	Time interval (sec.) for purge pump
Additional Config	Quick Start Display C & R Japanese config	Enable/Disable quick start buttons Enable/Disable lung mechanics values
Screen Intensity	Value	Increase/decrease the screen intensity
Language		Choosing the language
Enable PRVC	ON/OFF	Enable/Disable PRVC ventilation mode

Service/Technical Menu

Service Screen

Enable VG	ON/OFF	Enable/Disable VG ventilation mode
Customized BUV	ON / OFF	Setting customized BUV parameter. Password protected. Password is 0613
Saving Logs	OFF	Activate log files download. Refer to Chap. 8
Service SCREEN		Move to the calibrations screen

5.2 Service Screen



Button	Options	Description
Serial	OFF/EGD/JSON	Serial port output format.
SW Version		Displays the SW version of each CPU
Calibrate Pressure		Activate pressure calibration
Calibrate FIO2		Activate Oxygen sensor calibration
Volume Factor		Activate Volume factor calibration. Displays the saved calibration value
Calibrate Relief		Activate Over pressure relief valve calibration
SERVICE		Change serial numbers and working hours Enter the code 2009 , confirm by pressing ✓
Factory Defaults		Default calibration parameters, to recover from calibration data corruption. Enter the code 2009 , confirm by pressing ✓
Neb. Comp. *	Value	Volume compensation when nebulizer is on.
Calibrate O2 Leak *		Leak sensor calibration

Bar Intensity	Single/Full	Number of lit LEDs in the ventilator's pressure gauge
---------------	-------------	---

*** iO_2 INTERNAL MIXER MODEL ONLY**

6 Software Upgrade

Required equipment:

- USB storage device with the SW version (**.pkg** file)



Software upgrade will not run if the batteries are charged below 50%.

6.1 Installing the SW upgrade

1. Turn off the ventilator, disconnect from AC.
2. Copy the new SW version (**.pkg** file) to a USB storage device.
3. Plug the USB storage device to the vent USB port.
4. Connect the ventilator to AC.
5. The ventilator powers up and a software update screen opens, displaying the current version and the new version to update.
6. Press **OK** on the touch screen.
7. Once upgrade is done, the ventilator displays " Finished updating, please remove DOK"
8. Remove the USB storage device and press **OK** on the touch screen.
9. Turn on the ventilator, press **Technical** /  and press **Show Info**.
10. Verify the new software version is displayed.

6.2 Calibration integrity check

1. Set the ventilator to the same ventilation modes:
 - ACMV
 - VCV = 500 mL
 - PEEP = 5
 - P trig = -5.0
 - Rate = 15
 - Ti = 1
 - O₂ = 80%
 - Waveform = Square
2. Connect to a patient circuit. Perform circuit test.
3. Start ventilation.

4. Verify the following:
 - V_{ti}** Within the 450-550 spec.
 - P_{base}** 5 ± 1cm H₂O
 - O₂** 72% - 88% for External O₂ Mixer.
 76% - 84% for Internal O₂ mixer (iO₂) model
5. If any of those values is out of spec, perform the appropriate calibration and check again.

Required Equipment



7 Calibration and Verification tests

Required Equipment

- Adult test lung specified up to 90cm H₂O with adjustable lung compliance of C=10;20;50
- Pressure/flow analyzer, specified to 120cm H₂O, accuracy of 0.1 cmH₂O
- Screwdrivers:
 - Phillips screwdriver PH1
 - Flat screwdriver 0.8x4
 - Torx screwdriver BT10x200
- Reusable patient circuit (P/N V60-50000-60)
- Vacuum gauge, range to -1bar
- Oxygen Analyzer
- Parabolic resistors: Rp5;Rp20;Rp50 Made by Michigan Instruments Inc.
- Medical-grade Oxygen source (pressure over 50PSI)
- * Oxygen Mixer (By Flight Medical, P/N V13-00010-60) – for non IO2 models.

7.1 Calibration

7.1.1 Pressure Relief Calibration

- ➔ **To calibrate the pressure-relief mechanism:**
1. Connect the ventilator to the test lung using a patient circuit
 2. Set the test lung to minimum compliance
 3. Press **Technical** /  and then press **ADVANCED Screen**.
 4. Enter the code **5844**, and confirm by pressing 
 5. Press **SERVICE SCREEN**
 6. Press **Calibrate Relief** and then **Enter** /  to start the motor.
 7. Verify that there is no air leakage from the exhalation valve. Air should only be coming out via the pressure-relief valve.
 8. Verify that the displayed pressure reading is between 105 and 120 cmH₂O.
 9. If the pressure is not within this range, adjust the Relief valve:
 - While the calibration is running, place the ventilator in a way that the calibration screw is accessible from below (Refer to picture *Figure 72 – Adjusting the Pressure Relief Valve* below).

- Use a Philips screwdriver to adjust the relief valve by tightening or loosening the calibration screw located on the underside of the outlet fitting.



Figure 72 –Adjusting the Pressure Relief Valve



10. Press **Enter** /  to confirm the reading and to complete the calibration.

If the test fails:

- Check internal tubing connections.

7.1.2 Pressure Sensors Calibration

➔ To calibrate the pressure sensors:

1. Connect the ventilator to an external pressure meter using a reusable patient circuit.
2. Connect the pressure meter to the test lung.
3. Use the following settings for the test lung:
 - **C** = 10
 - **Rp** = 5
4. Press **Technical** /  and then press **ADVANCED Screen**.
5. Enter the code **5844**, and confirm by pressing .
6. Press **SERVICE SCREEN**
7. Disconnect the patient circuit from the ventilator to verify there is no pressure buildup in the circuit. Reconnect the circuit to the ventilator

Calibration and Verification tests

Calibration

- Press **Calibrate Pressure** and then **Enter /** . The ventilator starts to build pressure.
- The following screen opens:

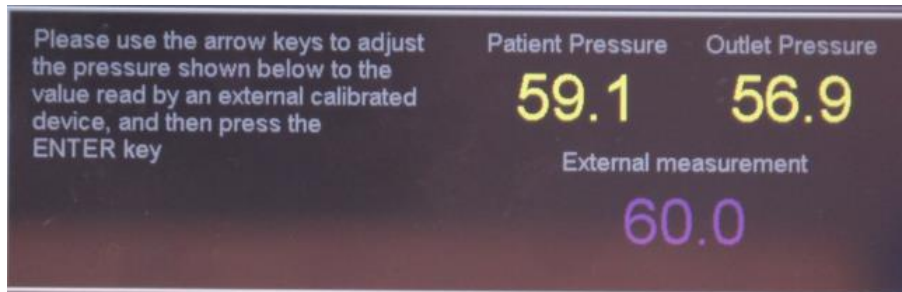

- Check the **Patient Pressure** and **Outlet Pressure** values, verify the following:
 - Values match the pressure measurement of the external pressure meter.
 - Values are between 50 and 75 cmH₂O.
 - The difference between the **Patient Pressure** and **Outlet Pressure** values is no more than 0.1.





If one of the conditions above is not met, calibrate the pressure sensors:

- If the pressure on the external pressure meter is in the 50-75 cmH₂O range**, continue to step 2.

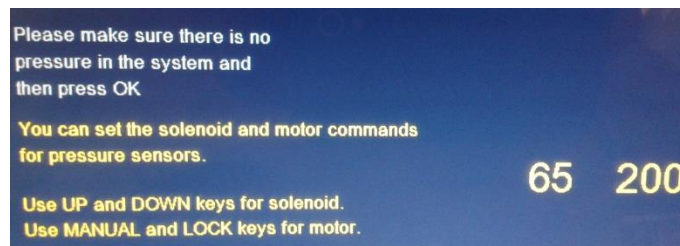
If the pressure is less than 50 cmH₂O:

- Press **Cancel /** .
- Press **Calibrate Pressure** again. The calibration screen will come up with the following message " *You can set the solenoid and motor commands for pressure sensor*" and displays default values of **65 200**.



- Use the **UP /**  and **DOWN /**  buttons to change the solenoid command (initial value of 65) or **Manual Breath /**  and **Panel lock /**  buttons to change motor command (initial value of 200) and press **Enter /** .
- Verify that the pressure on the external pressure meter is in the 50-75 cmH₂O range. If not then repeat the above steps until the pressure is the correct range.
- Continue to step 2.

2. Use the **UP** / **+** and **DOWN** / **-** buttons to change the **External measurement** value of 60 to the actual pressure reading of the external pressure meter.
3. Press **Enter** / **OK** . The ventilator stops.
4. Press **Calibrate Pressure** again and then **Enter** / **OK** .
5. Check the **Patient Pressure** and **Outlet Pressure** values, verify the following:
 - Values match the pressure measurement of the external pressure meter.
 - Values are between 50 and 75 cmH₂O.
 - The difference between the **Patient Pressure** and **Outlet Pressure** values is no more than 0.1.
6. Press **Cancel** / **X** to exit.

If the test fails:

1. Replace patient circuit and redo calibration.
2. Do one of the following:
 - If the external measurement lower than 50:
 - Check internal tubing connections for air leaks.
 - Replace the solenoid and redo calibration.
 - If the external measurement higher than 75:
 - Check internal tubing connections for blocking.
 - Replace the solenoid and redo calibration.
 - If the patient pressure / outlet pressure difference is more than 0.1cmH₂O:
 - Repeat the calibration up to 3 times. If the desired results are not obtained after three attempts:
 - Examine the silicon tube connections and try to locate a leak.
 - Verify that the relief valve is not activated.
 - Replace the solenoid (see 4.19). Perform the required calibrations (see 7.3 Test table).
 - Replace the Main Board (see 4.10). Perform the required calibrations (see 7.3 Test table).

Calibration





7.1.3 Volume Factor Calibration



Volume Factor calibration must be performed only with an Rp50 resistor manufactured by Michigan Instruments Inc.

Ventilator might not deliver the correct volume if another Rp50 is used for this calibration

→ **To calibrate the volume factor:**

1. Connect a patient circuit to the ventilator. Connect the RP50 resistor to the patient circuit and leave the other end of the resistor exposed to the open air, verifying that it is not blocked in any way.
2. Press **Technical** /  and then press **ADVANCED Screen**.
3. Enter the code **5844**, and confirm by pressing 
4. Press **SERVICE SCREEN**
5. Press **Calibrate Volume / Volume Factor** and follow the instructions which appear on the display.
6. After pressing **Enter** /  the ventilator will run volume factor calibration and display the volume factor value on the screen. The volume factor value should be between 0.85 and 1.2. Press **Enter** / .
7. Repeat the calibration again and verify that in both cases the volume factor values are the same. If not repeat the test until 2 consecutive matching volume factor values are achieved.

If the test fails:

1. Check internal tubing connections for air leaks.
2. Run the following tests:
 - Pressure sensor calibration
 - Circuit test
 - Pressure relief calibration
 - Volume factor calibration





If Volume Factor is still out of spec, Replace the manifold (see 4.12).

Perform the required calibrations (see 7.3 Test table).



7.1.4 Oxygen Sensor Calibration

➔ To calibrate the Oxygen sensor:

For iO₂ internal mixer model

1. Connect a high pressure oxygen hose to the High Pressure O2 port
2. Connect a calibrated Oxygen Analyzer to the ventilator's outlet. **Don't connect a patient circuit!**
3. Press **Technical** /  and then press **ADVANCED Screen**.
4. Enter the code **5844**, and confirm by pressing 
5. Press **SERVICE SCREEN**
6. Press **Calibrate FiO2**.
7. Choose **USED** if calibrating the current sensor, **NEW** if O₂ sensor is replaced.
8. The ventilator performs 21% calibration. Verify the external Oxygen analyzer reads 21%, wait 1 minute and press **Enter** / .
9. The ventilator switches to 100% automatically. Verify the external Oxygen analyzer reads 100%, wait 1 minute and press **Enter** / .

For External mixer model





1. Connect the Air/Oxygen Entrainment Mixer to an Oxygen source. Install the Air/Oxygen Entrainment Mixer on the ventilator's air inlet.
2. Set the regulator on the oxygen source to 50 PSI.
3. Connect a calibrated Oxygen Analyzer to the ventilator's outlet. **Don't connect a patient circuit!**
4. Press **Technical** /  and then press **ADVANCED Screen**.
5. Enter the code **5844**, and confirm by pressing 
6. Press **SERVICE SCREEN**
7. Press **Calibrate FiO2**.
8. Choose **USED** if calibrating the current sensor, **NEW** if O₂ sensor is replaced.
9. Set the Entrainment Mixer dial to AIR.
10. Once the external Oxygen sensor displays 21%, wait 1 minute and then press **Enter** / .
11. Set the Entrainment Mixer dial to 100%.

Calibration

12. Once the external Oxygen sensor displays 100%, wait 1 minute and then press **Enter /** .

7.1.5 O₂ Leak Sensor calibration* (*iO₂ Internal mixer model only*)

➔ To calibrate the O₂ leak sensor:

1. Connect a calibrated Oxygen Analyzer to the ventilator's outlet. **Don't connect a patient circuit!**
2. Press **Technical /**  and then press **ADVANCED Screen**.
3. Enter the code **5844**, and confirm by pressing .
4. Press **SERVICE SCREEN**.
5. Press **Calibrate O2 Leak**. The system will be flushed with ambient air.
6. Wait 2 minutes. Use the **UP /**  and **DOWN /**  buttons to match the displayed value with the external Oxygen analyzer reading.
7. Press **Enter /** .

7.2 Operational Verification Procedure (OVP)

7.2.1 Standard Ventilator Settings (STS)

Refer to the following specifications whenever *STS settings* are called for:

- ACMV
- VCV = 500 mL
- PEEP = 0
- P trig = -1.0
- Rate = 15
- Ti = 1
- Waveform = Square

For test lung:

- Rp=5
- C = 50 mL / cmH₂O

7.2.2 Front Panel Self Test

➔ **To run the self test:**

1. Connect the ventilator to AC power.
2. Press the **On Off** /  button on the front panel.
3. During the self test that begins automatically, check for the following:
 - Short audible beep
 - All LEDs on the **LED indicator** light up with the same intensity, with the following colors:

Description	Colour
TRIG (Pressure trigger)	Green
EXT PWR (External power)	Yellow
LOW BAT (Low battery)	Red
BAT (Battery power)	Orange
FAULT (Device malfunction)	Red
APNEA	Red
BUV (Back up ventilation)	Red
HIGH MV (High minute ventilation)	Red

Calibration and Verification tests

Operational Verification Procedure (OVP)

LOW MV (Low minute ventilation)	Red
High P (High pressure)	Red
LOW P (Low pressure)	Red
Audio Paused/Alarm Reset	Orange
On/Off	Green
Panel Lock	Orange

- All LEDs between 60 – 100 on the **pressure gauge** light up.

If the test fails:

No LEDs are on - Check the internal connectors to the front panel.

Some LEDs are on - Replace the Main Board

7.2.3 Circuit Test

Each time the Exhalation Valve or patient circuit is replaced or serviced, it must be tested.

➔ To test the patient circuit / exhalation valve:

1. Connect the patient circuit to a 0.5L test lung.
2. Press **Technical** / , and then press **Circuit TEST**.

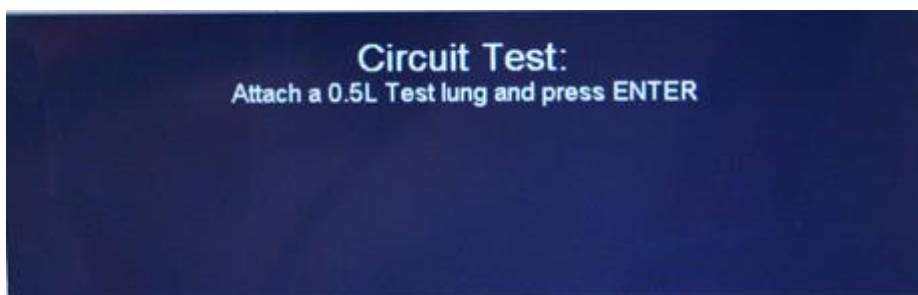

3. Press **Enter** /  .
4. The test is done automatically. It includes the following 3 steps:
 - Testing the motor
 - Finding Test Points: 6 calibration points in descending values. The first value should be at least 27.
 - Verifying: 3 verification points.

If the test is successful, the display reads **Test completed**.

If the test fails:

1. Press **Cancel** / .
2. Replace the patient circuit. In case of a Flight60 DL check the exhalation valve diaphragm.
3. Perform the calibration again.
4. Check internal tubing connections for air leaks.
5. Replace the solenoid and perform the required calibrations (see 7.3 Test table).

7.2.4 Volume verification

➔ **To test the device for pressure:**

1. Set the ventilator to STS settings.
2. Activate the ventilator and verify that the volume is between 450 and 550ml.

If the test fails:

Repeat the Volume factor calibration

7.2.5 Pressure Verification

➔ **To test the device for pressure:**

1. Set the ventilator to STS settings.
2. Connect a pressure meter between the ventilator and the test lung.
3. Use the following settings for the test lung:
 - C = 50
 - Rp = 5
4. Activate ventilation.
5. Set $T_i = 2$.
6. Verify that the external pressure meter reading and the **PIP** value displayed on the ventilator differ by no more than 2 cmH₂O or 10%. (The higher of the two can be used for this determination.)

If the test fails:

Operational Verification Procedure (OVP)

Repeat the following:

- Pressure sensors calibration
- Pressure relief calibration
- Volume factor calibration
- Circuit Test

7.2.6 PEEP

➔ To test the PEEP:

1. Use the following settings for the test lung:
 - C = 50
 - R_p = 5
 - If a test lung with analysis software is used, configure the analysis software program to the same settings
2. Connect a pressure meter between the ventilator and the test lung.
3. Set the ventilator to STS settings.
4. Set **PEEP** to 5.
5. Activate ventilation.
6. After 5 breaths, check that the basic pressure levels in the lung and in the ventilator display are 5 ±1 cmH₂O.
7. Raise the **P trig** level as needed, until no auto-triggering is observed.
8. Verify that the **P trig** level is not more than -1.5 cmH₂O, and that the ventilator is not performing an auto-trigger.
9. Set **PEEP** to 10.
10. After five breaths, check that the basic pressure levels in the lung and in the ventilator display are 10 ±2 cmH₂O.
11. Raise the **P trig** level as needed, until no auto-triggering is observed.
12. Verify that the **P trig** level is not more than -2 cmH₂O
13. Set **PEEP** to 20.
14. After five breaths, check that the basic pressure levels in the lung and in the ventilator display are 20 ±2 cmH₂O.
15. Raise the **P trig** level as needed, until no auto-triggering is observed.
16. Verify that the **P trig** level is not more than -3 cmH₂O.

If the test fails:

1. Replace the patient circuit. In case of a Flight60 DL replace the exhalation valve diaphragm.
2. Repeat Circuit test.
3. Replace the solenoid and run the required calibrations (see 7.3 Test table).

7.2.7 Pressure Trigger

➔ To test the pressure trigger:

1. Set the ventilator to STS
2. Connect the ventilator to the test lung using a patient circuit. Use the following settings for the test lung:
 - C = 50
 - Rp = 5
3. Activate ventilation.
4. Simulate inhalation attempt by creating a negative pressure from the test lung.
5. Verify that the green **P trig** LED flashes and a mandatory breath is forced each time the edge (shoulder) is raised.
6. Change settings to:
 - **SIMV**
 - **PSV** = 20
 - **Rate** = 5.
7. Simulate inhalation attempt by creating a negative pressure from the test lung.
8. Verify that the green **P trig** LED flashes and that the ventilator provides a mandatory breath followed by pressure-supporting ventilations (PSV) for 12 seconds.
9. Set the **P trig** level to -0.2 cmH₂O, and verify that no auto-triggering occurs.

If the test fails:

1. Replace the patient circuit. In case of a Flight60 DL replace the exhalation valve diaphragm.
2. Repeat the following:
 - Pressure sensors calibration
 - Pressure relief calibration
 - Volume factor calibration

Operational Verification Procedure (OVP)

- Circuit test
3. Replace the solenoid and perform the required calibrations (see 7.3 Test table).

7.2.8 Exhalation Valve Leak

➔ To test the exhalation valve:

1. Set the ventilator to the following settings:
 - Rate = 10
 - Ti = 1.4
 - ACMV
 - VCV = 1400
2. Set the High-Pressure alarm to 99 cmH₂O.
3. Connect the ventilator to a test lung using a patient circuit. Use the following settings for the lung:
 - C = 20
 - Rp = 20
4. Activate ventilation and continue for 15 breaths.
5. Verify that the pressure level is over 72 cmH₂O. If pressure doesn't get to 72 cmH₂O, decrease the compliance or increase the resistance of the test lung. If pressure becomes too high after changing compliance/resistance, reduce the set volume from 1400 until achieving the required pressure level.
6. Check for air flow from the underside of the Exhalation Valve during inhalation; If air flow is noticed there is a leak and the test fails.

If the test fails:

1. Replace the patient circuit. In case of a Flight60 DL replace the exhalation valve diaphragm.
2. Repeat the following:
 - Pressure sensors calibration
 - Pressure relief calibration
 - Volume factor calibration
 - Circuit test
3. Replace the solenoid (see 4.19), and perform the required calibrations (see 7.3 Test table)

7.2.9 High Pressure Alarm

➔ To test the high-pressure alarm:

1. Set the ventilator to STS settings
2. Connect the ventilator to a test lung using a patient circuit.
3. Activate ventilation.
4. Set **HIGH P** to 10 cmH₂O.
5. Check that when the pressure reaches 10 cmH₂O, the following occurs:
 - the audible alarm is triggered
 - the visual alarm is triggered
 - inhalation is interrupted.
6. Set **HIGH P** to 99 cmH₂O.
7. Check that the following occurs:
 - the audible alarm is silenced automatically
 - the visual alarm is displayed until the **Alarm Reset** /  button is pressed.

If the test fails:

1. Replace the Main Board (see 4.10).
2. Perform the required calibrations (see 7.3 Test table).

7.2.10 Battery /Charger /Power Supply

➔ To test the power supply:



Verify that both batteries are above 60%. If not, connect to external power and charge for at least 3 hours.

1. Disconnect the ventilator from AC power
2. Verify that the following occur:
 - the **Power Switchover** indicator is displayed
 - an audible beep is heard

Operational Verification Procedure (OVP)

- the **EXT PWR** indicator is not lit (external power)
 - the battery (**BAT**) LED indicator is lit
3. Verify that the ventilator functions normally with no further alarms.
 4. After at least 90 seconds have passed, reconnect to AC power.
 5. Verify that within 30 seconds of the connection time the ventilator indicates switching back to AC power.
 6. Verify that the following occur:
 - the battery (**BAT**) LED indicator is off
 - the green **EXT PWR** is lit

7.2.11 Inlet Leak

➔ **To test the inlet leak:**

1. Set the ventilator to STS settings.
2. Connect the ventilator to a test lung using a patient circuit.
3. Verify that the three screws securing the filter cover are tight, to insure that air leakage is prevented.
4. Connect a vacuum meter to the air inlet.
5. Activate ventilation.

The vacuum reading should be at least -0.16 (negative 0.16) Bar at the end of expiration.



During expiration, a decrease in the vacuum meter's negative pressure is normal.



If the test fails:

1. Tighten the screws locking the filter cover.
2. Replace the filter.
3. Remove the filter cover and check the O-ring.
4. Check the Inlet-to-muffler connection for a leak.

7.2.12 Buzzer Test

➔ To test the buzzer:

Press **Parameters** /  and choose **Screen ALARMS**.

5. Tap the **Buzzer** button.
6. Choose HIGH and press **Enter** / . Verify that a High buzzer sound is heard.
7. Tap the **Buzzer** button.
8. Choose LOW and press **Enter** / . Verify that a Low buzzer sound is heard.

If the test fails:

- Check the buzzers cables. Make sure they are connected to the Main Board and are intact.
- Replace the Main Board (see 4.10), and perform the required calibrations (see 7.3 Test table).

7.2.13 Oxygen Calibration Test

For non iO₂ ventilator (no internal O₂ mixer)

Connect an external Air/Oxygen Entrainment Mixer to an Oxygen source. Install the Air/Oxygen Entrainment Mixer on the ventilator's air inlet.

O₂% settings are changed with the mixer dial.

For iO₂ ventilator (with internal O₂ mixer)

Connect the ventilator to an Oxygen source.

O₂% settings are changed by the %O₂ button on the touch screen

1. Press **Technical** /  and then press **O₂ sensor**.
2. Select **ON**.
3. Set the Low FiO₂ and the High FiO₂ alarm to **OFF**.
4. Connect the patient circuit via a calibrated Oxygen Analyzer to the test lung.
5. Set the ventilator to STS mode. Start ventilation.

Operational Verification Procedure (OVP)

6. Change O₂ settings according to the following test table:

Input pressure	Mixer settings	Tolerance for IO ₂ internal mixer	Tolerance for External mixer
50 PSI	40%	36% - 44%	32% - 48%
	60%	57% - 63%	52% - 68%
	80%	76% - 84%	72% - 88%
	100%	95% - 100%	92% - 100%

If the test fails:





1. Check for an inlet leak (see section 7.2.11).
2. Replace the sensor cable.
3. Replace the sensor.
4. Replace the Main Board (see 4.10) and perform the required calibrations (see 7.3 Test table).

7.2.14 Nebulizer compensation test * (*iO₂ Internal mixer model only*)

➔ **To test the Nebulizer compensation**

1. Set the ventilator to STS mode.
2. Connect a nebulizer circuit **before the patient circuit's flow sensor**. Start ventilation.
3. Verify that V_{ti} is 450-550.
4. Set O₂ mixer to 50%. Activate the Nebulizer.
5. Verify that V_{ti} remains in the 450-550 range.

If the test fails:

1. Press **Technical** /  and then press **ADVANCED Screen**.
2. Enter the code **5844**, and confirm by pressing .
3. Press **SERVICE SCREEN**
4. Use the **UP** /  and **DOWN** /  buttons to change the **Neb. Comp.** value. Increasing the value will decrease V_{ti}.

7.2.15 OVP Test Results

Serial #:	SW Version:	Hours:
Model:	Tested By:	Date:

Test	Results	Pass
<i>Front Panel self- test</i>	-N/A-	<input type="checkbox"/>
<i>Pressure Sensors Calibration</i>	External pressure gauge Patient Pressure Outlet Pressure	<input type="checkbox"/>
<i>Pressure Relief Valve Calibration</i>	Relief Pressure	<input type="checkbox"/>
<i>Volume Factor Calibration</i>	<input type="checkbox"/>
<i>Circuit Test</i>	-N/A-	<input type="checkbox"/>
<i>Volume Verification</i>	Vti Vte	<input type="checkbox"/>
<i>Pressures Verification</i>	External gauge peak Pressure PPeak	<input type="checkbox"/>
<i>PEEP</i>	Set Tolerance PEEP Value Ptrig	<input type="checkbox"/>
	5 5 ± 1	
	10 10 ± 2	
	20 20 ± 2	
<i>Pressure Trigger test (P trig)</i>	-N/A-	<input type="checkbox"/>
<i>Exhalation Valve leak</i>	Pressure level	<input type="checkbox"/>
<i>High Pressure Alarm</i>	-N/A-	<input type="checkbox"/>
<i>Power Supply and Battery Charge</i>	-N/A-	<input type="checkbox"/>
<i>Inlet Leak</i>	<input type="checkbox"/>
<i>Alarm Buzzer Test</i>	-N/A-	<input type="checkbox"/>
<i>O2 Sensor</i>	Set Tolerance Value	<input type="checkbox"/>
	Air 20.9% - 29%	
	40% 32% - 48%	
	60% 52% - 68%	
	80% 72% - 88%	
	100% 92% - 100%	

Test Table

7.3 Test Table

The following table summarizes tests associated with each device module. When a module is replaced, All tests associated with the replacement must be performed before the ventilator is used again.

Module	Detachable battery	Internal battery	Power board	Power supply	Front panel	Main board	Mixer board	Manifold	O ₂ sensor	O ₂ leak sensor	Purge board	Solenoid board	Solenoid	Internal O ₂ mixer	Fuse
Calibration /Test															
Pressure sensor calibration					✓	✓		✓				✓	✓		
Pressure relief calibration						✓									
Volume factor calibration					✓	✓		✓							
Oxygen sensor calibration					✓	✓			✓						
O ₂ leak sensor calibration							✓			✓					
Pressure verification				✓	✓	✓		✓	✓		✓	✓	✓		
PEEP					✓	✓		✓			✓	✓	✓		
Pressure trigger					✓	✓		✓	✓		✓	✓	✓		
Exhalation Valve leak								✓	✓		✓	✓	✓		
High pressure alarm					✓	✓									
Battery/charger/power supply	✓	✓	✓	✓	✓	✓									✓
Inlet leak								✓							
Buzzer test		✓	✓	✓	✓	✓									
Internal O ₂ mixer							✓		✓					✓	
Nebulizer							✓		✓					✓	
Front panel			✓	✓	✓	✓									✓



8 Maintenance

8.1 Scheduled maintenance

MANIFOLD – The manifold should be replaced every 15,000 hours of operation or every 3 years, whichever comes first.

For instructions on replacing the manifold, see section 4.12

After replacing the manifold, update the manifold serial number and zero the working hours:

1. Press **Technical** /  and then press **ADVANCED Screen**.
2. Enter the code **5844**, and confirm by pressing .
3. Press **SERVICE SCREEN**
4. Press **SERVICE**
5. Enter the code **2009**, and confirm by pressing .
6. Press the displayed **Compressor Serial Number**, use the numerical keyboard to type in the new number.
7. Press the displayed **Hour Meter**, use the numerical keyboard to change it to "0"

AIR INLET FILTER – Check the filter's condition whenever servicing the ventilator.



OXYGEN (O₂) SENSOR – Replace once a year.

O₂ LEAK SENSOR – Replace once a year.

BATTERY – Recommended replacement – every 2 years.



8.2 Download Log Files

To save log files use a FAT formatted USB mass storage device.

1. Press **Technical** /  and then press **ADVANCED Screen**.
2. Enter the code **5844**, and confirm by pressing .
3. Press **SERVICE SCREEN**
4. Plug the USB storage device to the ventilator.

Maintenance

Download Log Files

5. Change **Auto Logs** to **ON**. The download icon  will display.
6. Wait for the download complete icon  to display. Note that It might take few minutes for download to complete, depending on the size of the log files
7. Check the USB device on a computer and verify that 3 log files – **errors**; **changes**; **events** were downloaded.

9 Troubleshooting Guide

9.1 Introduction

The FLIGHT 60 Ventilator is used in life-support situations. As such, it is essential that all individuals using the FLIGHT 60 Ventilator, including clinicians and support staff, have a thorough understanding of its operation. This should include a working knowledge of the ventilator's pneumatic and electronic systems.

The following practical troubleshooting section is provided as a training resource for individuals learning how to use the FLIGHT 60 Ventilator, and as a reference tool for those already familiar with its use and operation. It should be noted that this outline is not all inclusive, and is intended only as a guide.



Only properly trained personnel should operate the ventilator. The FLIGHT 60 Ventilator is a restricted medical device designed for use by Respiratory Therapists or other properly trained and qualified personnel under the direction of a physician and in accordance with applicable state laws and regulations.

9.2 Error Messages

Displayed error	Potential Cause	Suggested Action
CHECK FiO ₂ SENSOR	Oxygen sensor bad reading Oxygen sensor defective	Run Oxygen sensor calibration Replace Oxygen sensor
O ₂ SUPPLY FAILED	O ₂ pressure is very low	Check O ₂ source pressure is 30-90PSI Replace the O ₂ Regulator filters
PROX LINE	Problem in the proximal line. Pressure sensors is improperly calibrated or defective.	Check internal hoses connections Pressure Sensors Calibration Replace Main Board
FLOW SENSOR ERROR	Processor defective Processor communication problem	Replace Main Board
EMPTY BAT	Combined charge of both batteries is less than 30%.	Connect to AC (charging) for 3 hours Replace Power Board

Troubleshooting Guide

Error Messages

Displayed error	Potential Cause	Suggested Action
HIGH MV INS	Air leakage	Check internal hoses connections
HIGH MV EXH	Calibration problem Hardware problem	Check internal hoses connections Perform Volume factor calibration Replace Main Board Replace manifold
HIGH / LOW P BASE	Solenoid malfunction	Check solenoid Perform Circuit Test Replace solenoid
PCV NOT REACHED	Calibration problem Hardware problem	Perform Volume Factor calibration Replace manifold
LOW MV EXH	Air leak Hardware problem	Check internal hoses connections Replace Main Board
MOTOR FAULT	Motor control Motor	Replace Power Board Replace manifold
PRESS SENSOR	Patient pressure sensor higher than outlet	Perform Pressure sensors calibration Replace Main Board
POWER FAULT	Check log file to identify failed power:	
	3.3V POWER FAULT	Replace Main Board
	MAIN BOARD 10V POWER FAULT	Check cables Replace Power Board Replace Main Board
	POWER BOARD 10V POWER FAULT	Check cables Replace Power Board
	5V POWER FAULT	Replace Main Board
MEMORY FAULT	Parameters mismatch	Perform OVP Replace Main Board
MAIN BAT CHARGER	Charger malfunction	Replace battery Replace Power Board
MAIN BAT V HIGH / LOW	Out of range	Replace battery Replace Power Board

Displayed error	Potential Cause	Suggested Action
MAIN BAT VOLTAGE	Mismatch in Battery voltage reading	Replace battery Replace Main Board
MAIN BAT TEMP HIGH	Battery overheating	Replace battery Replace Power Board
MAIN BAT GAUGE	Battery control	Replace battery
SEC BAT CHARGER	Charger malfunction	Replace battery Replace Power Board
SEC BAT V HIGH / LOW	Out of range	Replace battery Replace Power Board
SEC BAT VOLTAGE	Mismatch in Battery voltage reading	Replace battery Replace Main Board
SEC BAT TEMP HIGH	Battery overheating	Replace battery Replace Power Board
SEC BAT GAUGE	Battery control	Replace battery

10 Repackaging and Shipping

All returned items must have a Return Goods Authorization (RGA) number, assigned by FLIGHT MEDICAL.

To obtain an RGA number, email a completed RGA form (filled in its entirety) to support@flight-medical.com. Also include the ventilator's log files and a detailed description of the failure analysis and the repair efforts undertaken.

Items can be returned only after an RGA number was provided by FLIGHT MEDICAL.

Copies of the RGA form and the Service Call should be included with the returned item.

RGA Returns



Use the following guidelines to return a FLIGHT 60 ventilator:



- Use the original box and packaging.
- Remove both batteries and any accessories from the ventilator.
- When returning a module, place it in the original box and packaging. If not available, place it in a box large enough to allow for it to be wrapped in a sufficient amount of packaging material.
- Write the RGA number on the shipping label.

Ship RGA items to: FLIGHT MEDICAL INNOVATIONS Ltd.
13 Hamelacha St
Lod 71520, ISRAEL
Tel: +972-8-923-5111

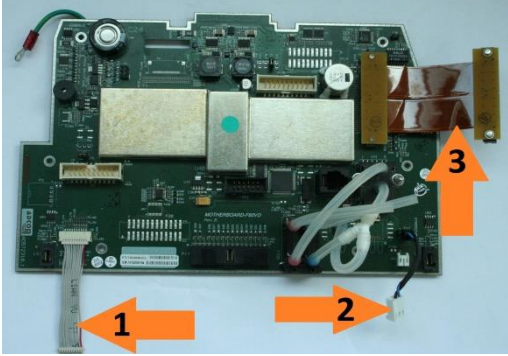
11 Spare parts

11.1 Electronic

<p style="text-align: center;">Main Board SUB-0202</p> <p><i>Connecting cables – not part of the board:</i></p> <table border="1"> <tr> <td style="text-align: center;">1</td> <td>MB to SB cable</td> <td>V60-70100-29</td> </tr> <tr> <td style="text-align: center;">2</td> <td>O₂ sensor cable</td> <td>V60-00130-29</td> </tr> <tr> <td style="text-align: center;">3</td> <td>FPC MB to PB cable</td> <td>V60-21000-29</td> </tr> </table>	1	MB to SB cable	V60-70100-29	2	O₂ sensor cable	V60-00130-29	3	FPC MB to PB cable	V60-21000-29	
1	MB to SB cable	V60-70100-29								
2	O₂ sensor cable	V60-00130-29								
3	FPC MB to PB cable	V60-21000-29								
<p style="text-align: center;">Power Board V60-21000-65</p> <p><i>Connecting cables – not part of the board:</i></p> <table border="1"> <tr> <td style="text-align: center;">1</td> <td>FPC MB to PB cable</td> <td>V60-21000-29</td> </tr> </table>	1	FPC MB to PB cable	V60-21000-29							
1	FPC MB to PB cable	V60-21000-29								
<p style="text-align: center;">Power Supply SUB-0174</p>										

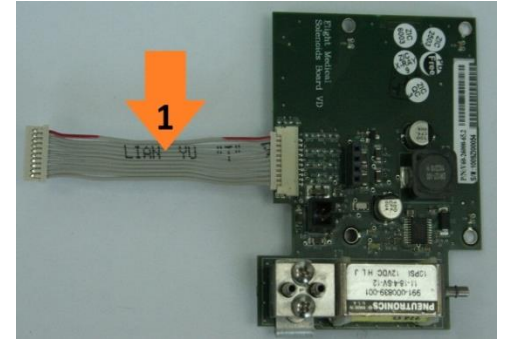
<p>Lower Board V60-22000-65</p>			
<p>D-Type Board V60-24000-65</p>			
<p>Purge Board V60-23000-65</p>			
<p>Solenoid Board V60-26000-65</p> <p><i>Connecting cables – not part of the board:</i></p> <table border="1" data-bbox="245 1562 829 1612"> <tr> <td data-bbox="245 1562 548 1612">1 MB to SB cable</td> <td data-bbox="548 1562 829 1612">V60-70100-29</td> </tr> </table>	1 MB to SB cable	V60-70100-29	
1 MB to SB cable	V60-70100-29		





11.2 Mechanical / Assemblies

<p style="text-align: center;">Front Subassembly</p> <p style="text-align: center;">SUB-0195 - English Keypad SUB-0194 - Symbols Keypad</p> <p><i>Connected items:</i></p> <table border="1"> <tbody> <tr> <td style="text-align: center;">1</td> <td>Front right bracket</td> <td>V60-76023-03</td> </tr> <tr> <td style="text-align: center;">2</td> <td>Front Left bracket</td> <td>V60-76022-03</td> </tr> </tbody> </table>			1	Front right bracket	V60-76023-03	2	Front Left bracket	V60-76022-03	 <p>A photograph of the front subassembly, showing the keypad area. Two orange arrows labeled '1' and '2' point to the front right and left brackets respectively.</p>
1	Front right bracket	V60-76023-03							
2	Front Left bracket	V60-76022-03							
<p style="text-align: center;">Manifold</p> <p style="text-align: center;">V60-21000-60</p>			 <p>A photograph of the manifold assembly, a complex metal component with various ports and connections.</p>						
<p style="text-align: center;">Solenoid</p> <p style="text-align: center;">V60-21400-69</p>			 <p>A photograph of the solenoid assembly, a cylindrical component with a green cap and a blue connector.</p>						
<table border="1"> <tbody> <tr> <td style="text-align: center;">1</td> <td>Filter Cover</td> <td>V11-35001-63</td> </tr> <tr> <td style="text-align: center;">2</td> <td>O-ring</td> <td>V11-36000-26</td> </tr> </tbody> </table>			1	Filter Cover	V11-35001-63	2	O-ring	V11-36000-26	 <p>A photograph showing the filter cover (1) and the O-ring (2). The filter cover is a circular metal plate with a handle and text: "FILTER COVER", "LUBRICANT RESIDUE TO REMOVAL COVER", "DO NOT BLOCK!", "SECURELY TIGHTEN SCREWS!". The O-ring is a red rubber ring.</p>
1	Filter Cover	V11-35001-63							
2	O-ring	V11-36000-26							







Spare parts



Mechanical / Assemblies

<p>Oxygen Sensor / Leak sensor G60-25000-29</p>							
<p>Air/Oxygen Entrainment mixer V13-00030-60</p>							
<table border="1"> <tr> <td colspan="3" data-bbox="215 932 831 1121"> <p>Inlet Assembly V60-15000-63</p> </td> </tr> <tr> <td data-bbox="215 1121 269 1194"> <p>1</p> </td> <td data-bbox="269 1121 589 1194"> <p>Silicon tube</p> </td> <td data-bbox="589 1121 831 1194"> <p>V60-32000-06</p> </td> </tr> </table>	<p>Inlet Assembly V60-15000-63</p>			<p>1</p>	<p>Silicon tube</p>	<p>V60-32000-06</p>	
<p>Inlet Assembly V60-15000-63</p>							
<p>1</p>	<p>Silicon tube</p>	<p>V60-32000-06</p>					
<p>Internal Mixer Nebulizer SUB-0101</p>							

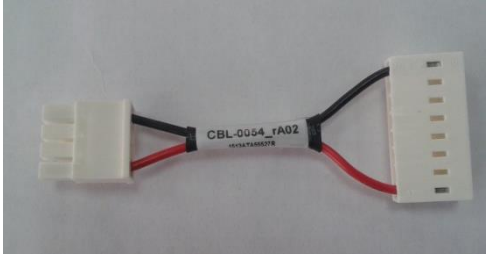
<p>Muffler MEC-0040</p>		
<p>L connector G27-00017-27</p>		
<p>Flex tube short V60-25010-06</p>		
<p>Flex tube long V60-25020-06</p>		
<p>For Dual Limb Ventilator</p>		
1	Dual limb Cap	SUB-0088
2	Diaphragm (5 pcs)	V64-00050-90
3	Exhalation Valve DL	MEC-0034
		

11.3 Cables

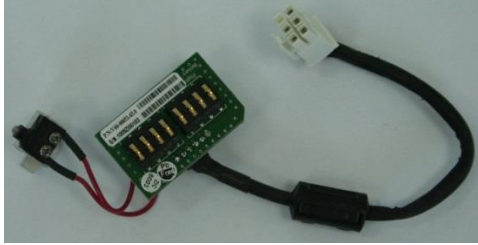
<p>Internal AC Cable CBL-0053</p>	 A black power cord with a three-pronged AC plug.
<p>Internal DC Cable V60-40200-29</p>	 A black cable with a blue connector on one end and a white connector on the other.
<p>FPC MB-PB cable V60-21000-29</p>	 A flat, flexible ribbon cable with gold-colored connectors on both ends.
<p>MB – SB cable V60-70100-29</p>	 A flat, flexible ribbon cable with multiple pins on both ends.
<p>DC-DC cable (power supply – Power board) CBL-0054</p>	 A cable with a white connector on one end and a multi-pin connector on the other. The label reads "CBL-0054_rA02".
<p>Detachable Battery cable V60-00050-29</p>	 A black cable with a green PCB connector on one end and a white connector on the other.

<p>Internal Battery cable V60-50100-29</p>	 A photograph of an internal battery cable. It features a green printed circuit board (PCB) with several gold-plated pins. A black braided shielded cable is connected to the board, ending in a white multi-pin connector. Red and black wires are also visible on the left side of the board.
<p>Oxygen Sensor cable V60-00130-29</p>	 A photograph of an oxygen sensor cable. It consists of a black braided shielded cable with a white multi-pin connector at one end and a black sensor connector at the other.
<p>O₂ Leak sensor cable SUB-0010</p>	 A photograph of an O ₂ leak sensor cable. It is a black braided shielded cable with a white multi-pin connector at one end and a black sensor connector at the other.

Index

A

- AC connector, 3-6
- ACMV, 6-3, 7-12, 7-17
- Air/Oxygen Entrainment Mixer, 2-2, 2-3, 3-5, 7-10, 7-20
- Alarm connector, 3-6
- Alarm Reset button, 3-1, 3-3
- Antistatic wrist strap, 4-1
- APNEA, 3-3
 - LED Indicator, 3-3
 - LED Indicator, 7-12
- Audio Paused button, 3-1
- Audio Paused/Alarm Reset
 - LED Indicator, 7-13

B

- Back panel
 - AC connector, 3-6
 - DC connector, 3-6
 - Detachable battery, 3-6
 - Low flow oxygen port, 3-7
 - Network logging, 3-7
 - PC connector, 3-6
 - Peripherals connector, 3-7
 - Remote alarm connector, 3-6
 - Uploading log files, 3-7
- BAT
 - LED Indicator, 3-3, 7-19, 9-3, 9-4, 9-5
 - LED Indicator (Battery power), 7-12
- Battery, 4-2, 7-18, 9-5
- Button
 - Alarm Reset, 3-1, 3-3
 - Audio Paused, 3-1
 - Cancel, 3-3
 - Decrease, 3-3
 - Extended, 3-3
 - Home, 3-2
 - Increase, 3-3
 - Manual breath, 3-1
 - Manual breath, 3-2
 - OK, 3-3
 - On/Off, 3-1, 3-3
 - Panel lock, 3-1
 - Panel lock, 3-3
 - Parameters, 3-2
 - Technical, 3-3
 - Up/Down, 3-1
- BUV
 - LED Indicator, 3-3
 - LED Indicator (Back up ventilation), 7-12
- Buzzer Test, 7-20

C

- Cable ties, 4-1
- Cancel button, 3-3
- Charger, 7-18, 9-4, 9-5
- Connector, patient circuit, 3-1
- Ventilator Cover, 4-3, 4-5, 4-6
- Cutter, 4-1

D

- DC connector, 3-6
- Decrease button, 3-3
- Detachable battery, 3-6
- Detachable Battery, 4-2
- Display touch screen, 3-2
- D-type Board, 4-36
- Dual limb exhalation valve, 3-2

E

- Electrical Diagram, 3-14
- Emergency Air Intake, 3-4
- Error Messages, 9-3
- Error! Reference source not found.** Calibration, 7-13
- EXT PWR
 - LED Indicator, 3-3
 - LED Indicator (External power), 7-12
- Extended button, 3-3

F

- FAULT
 - LED Indicator, 3-3, 9-4
 - LED Indicator (Device malfunction), 7-12
- FILTER, 8-1**
- Filter Cover, 3-5
- Flat screwdriver, 4-1, 7-5
- Fresh Gas Intake, 3-5
- Front Panel, 3-1, 4-14, 4-15, 4-16, 4-17, 4-20, 7-12
- Front Panel Assembly, 4-14, 4-17
- Front Panel Self Test, 7-12
- Fuse, 4-39, 4-40

H

- HIGH MV
 - LED Indicator, 3-3, 9-4
 - LED Indicator (High minute ventilation), 7-12
- High P
 - LED Indicator (High pressure), 7-13
- HIGH P
 - LED Indicator, 3-3, 7-18
- High Pressure Alarm, 7-18
- Home button, 3-2

I

Increase button, 3-3
Inlet Leak, 7-19
Internal Battery, 4-2, 4-3

L

LED indicator, 3-2
LED Indicators, 3-3
LOW MV
 LED Indicator (Low minute ventilation), 7-13
LOW BAT
 LED Indicator, 3-3
 LED Indicator (Low battery), 7-12
Low flow oxygen port, 3-7
LOW MV
 LED Indicator, 3-3, 9-4
LOW P
 LED Indicator, 3-3, 9-4
 LED Indicator (Low pressure), 7-13
Lower Board, 4-36

M

Main board, 3-9, 3-10
Main Board, 4-14, 4-18, 4-20, 4-21, 7-13, 7-18, 7-20, 7-21, 9-3, 9-4, 9-5
Maintenance, 8-1
MANIFOLD, 8-1
Manifold Assembly, 4-22, 4-26
Manual breath button, 3-1, 3-2

N

Network logging, 3-7

O

OK button, 3-3
On/Off, 7-12
 LED Indicator, 7-13
On/Off button, 3-1, 3-3, 7-12
Oxygen (O₂) Sensor, 3-9, 3-10
Oxygen Blending Bag Kit, 2-2, 2-3
Oxygen Sensor, 4-27, 4-28, 7-20

P

Panel Lock
 LED Indicator, 7-13
Panel lock button, 3-1, 3-3
Parameters button, 3-2
Patient Circuit
 Reusable, 7-5
Patient circuit connector, 3-1
PC connector, 3-6
PEEP, 6-3, 7-12, 7-15
Peripherals connector, 3-7

Phillips screwdriver PH1, 4-1, 7-5
PLT1M-M69, 4-1
PLT4S-M69, 4-1
Power Board, 4-6, 4-7, 4-8, 4-9, 4-10, 9-3, 9-4, 9-5
Power board (PB), 3-9, 3-10
Power Supply, 4-7, 4-10, 4-12, 4-14, 7-18
Power supply (PS), 3-9, 3-10
Pressure gauge, 3-2
Pressure Relief Calibration, 7-8
Pressure Sensors Calibration, 7-5, 9-3
Pressure Trigger, 7-16
Pressure Verification, 7-14
Primary alarm LED, 3-2
Purge board, 3-9, 3-10
Purge Board Assembly, 4-31, 4-32

R

Remote alarm connector, 3-6
Removing and Reinstalling Modules, 4-1
Repackaging, 10-1
RGA number, 10-1
Rubber Bumpers, 4-40, 4-41

S

OXYGEN SENSOR

Oxygen, 8-1

Shipping, 10-1
Solenoid Assembly, 4-34, 4-36
Solenoid Board Assembly, 4-32, 4-33
Standard Ventilator Settings (STS), 7-12, 7-14, 7-15, 7-16, 7-18, 7-19

T

Technical button, 3-3
Test Table, 7-23
Torx screwdriver BT10x200, 4-1, 7-5
Touch Screen, 4-21
TRIG
 LED Indicator, 3-3
 LED Indicator (Pressure trigger), 7-12
Troubleshooting Guide, 9-3

U

Uploading log files, 3-7

V

V60-13000-65, 3-9, 3-10
V60-21000-60, 3-9, 3-10
V60-21000-65, 3-9, 3-10
V60-21400-69, 3-9, 3-10
V60-23000-65, 3-9, 3-10
V60-25000-29, 3-9, 3-10
V60-26000-65, 3-9, 3-10
V60-60002-65, 3-9, 3-10

Verification, 2-3, 7-5

Volume Factor Calibration, 7-9